

COMX-P4040 & COMX-P4080

High Performance Freescale QorIQ™ Modules

■ Embedded Computing for Business-Critical Continuity™

PRELIMINARY DATA SHEET

COM Express based modules with QorIQ™ processing power for rapid deployment across diverse I/O requirements

- Freescale QorIQ P4040 and P4080 processors
- Four or eight Power Architecture cores running at 1.5 GHz
- Supports two channels of 2GB DDR3-1333 ECC SO-UDIMM (4GB max.)
- 95 mm x 125 mm COM Express Basic footprint
- 12 configurable SERDES lanes available for maximum flexibility

The COMX-P4040 and COMX-P4080 modules from Emerson Network Power provide the performance and features of the Freescale QorIQ™ processors on ready-to-go pluggable mezzanine modules. By incorporating and leveraging the mechanical features and dimensions of the COM Express® specification, these modules exhibit all the best attributes of the COM Express open standard enabling shorter development schedules and faster time-to-market. Emerson has a range of QorIQ based COM Express form factor modules to enable scalable product strategies with multiple performance levels. This open, standardized approach fosters competitive pricing, greater upgrade flexibility and longevity of support.

The QorIQ P4040 and P4080 processors are effectively system-on-chip (SOC) devices with a range of features including high-performance datapath acceleration and network processing in a low power envelope making the COMX-P4040 and COMX-P4080 modules suitable for combined control, datapath and application layer processing. Underpinning the high-compute capability of these modules are the multiple Power Architecture e500mc cores which are complemented by highly flexible I/O including 10G-XAUI, SRIO, GPIO, USB 2.0, PCI Express, Gigabit Ethernet and real-time debug.

The dimensions of the COMX-P4040 and COMX-P4080 modules are 95 mm x 125 mm which enable them to fit within a very wide range of enclosures when mounted on a customer carrier. They are off-the-shelf processor solutions that isolate you from the complexities of high speed processor and memory system design, allowing you to concentrate on a carrier tailored to application I/O needs.

By combining the tried and tested Power Architecture processor cores along with a considerable range of on-module I/O, the COMX-P4040 and COMX-P4080 are suitable for a range of applications including enterprise and service provider routers, switches, base-station controllers, radio network controllers (RNCs), long-term evolution (LTE) and general-purpose embedded computing systems in the networking, telecom/datacom, wireless infrastructure, military and aerospace markets.

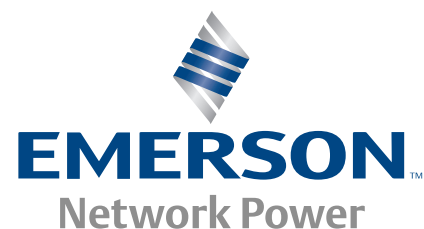
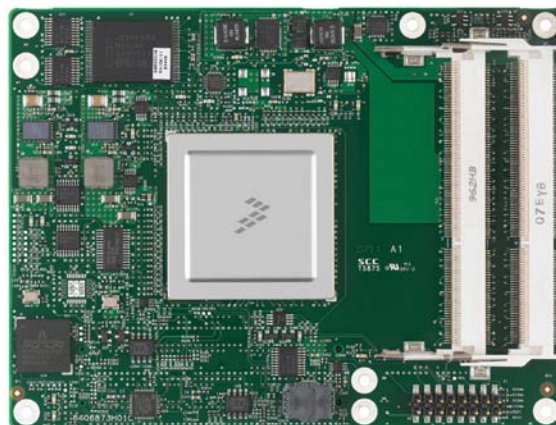

COMX-P4040 & COMX-P4080 Block Diagram

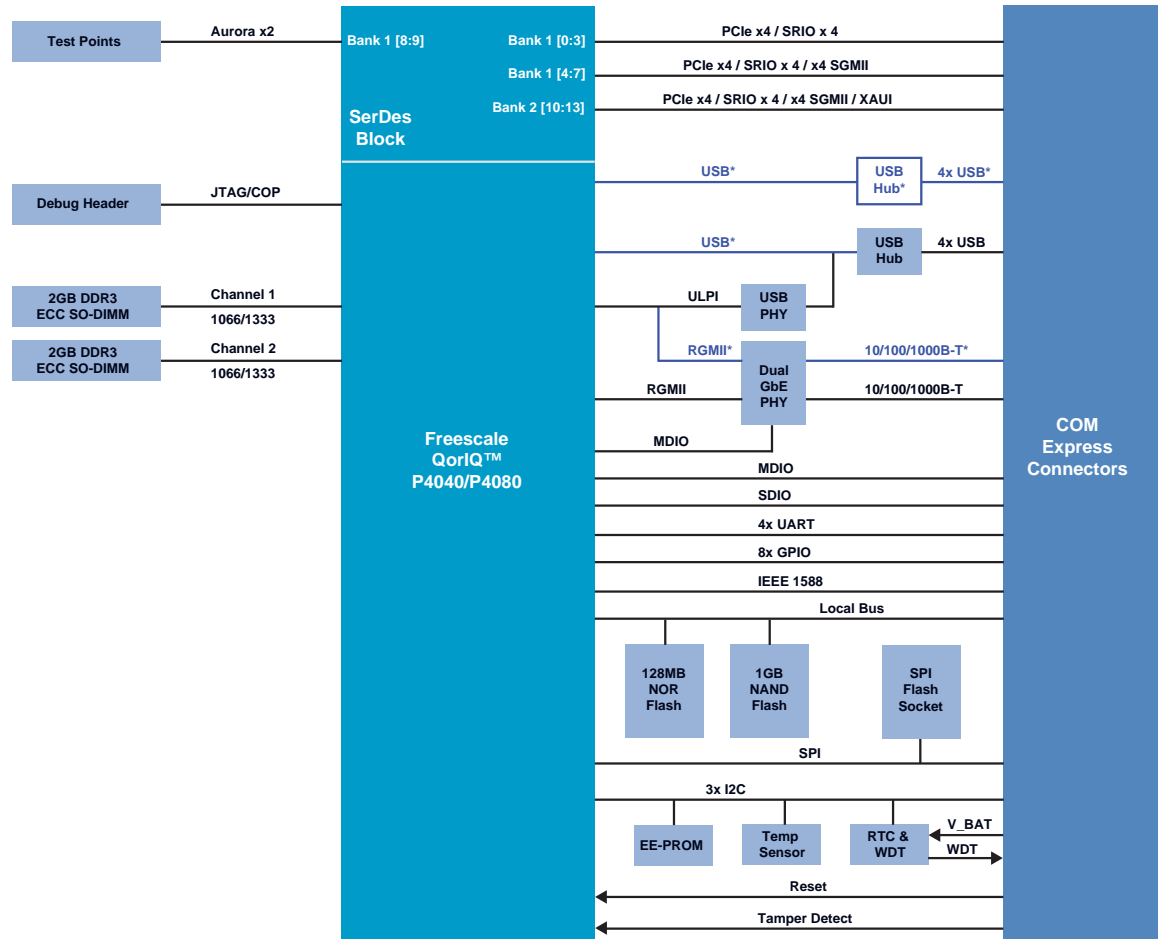

*Not supported on COMX-P4040

Hardware Specifications

PROCESSOR

- Freescale QorIQ P4080, eight cores running at 1.5 GHz
- Freescale QorIQ P4040, four cores running at 1.5 GHz

FORM FACTOR

- 95 mm x 125 mm COM Express Basic size

BOOTLOADER

- U-boot

MEMORY

- Support for 4GB DDR3-1333 ECC SO-UDIMM (two channels of 2GB)

ON-BOARD STORAGE

- 128MB NOR flash
- 1GB NAND flash
- 2kilobit EEPROM

ON-BOARD I/O

- JTAG Debug

I/O TO THE CARRIER

12 configurable SERDES lanes available for maximum flexibility in customer platform design. Available interfaces include:

- Up to one (1) 10 GbE XAU1 3.125Gbps
- Up to four (4) 1 GbE SGMII 1.25 Gbps
- Up to three (3) PCI Express (x4) 2.5 or 5Gbps
- Up to two (2) SRIO (4x) 2.5 or 3.125 Gbps

OTHER I/O AT THE CONNECTOR

- Four (4) UART ports
- One (1) Gigabit Ethernet interface (10/100/1000Base-T)
- Two (2) MDIO
- One (1) SDIO
- Eight (8) general purpose I/O (GPIO) ports
- Three (3) I²C bus
- Five (5) IRQ interrupts
- Four (4) USB 2.0 ports
- IEEE 1588 control
- Tamper detection
- Real-time clock
- Watchdog timer
- SPI Bus with four (4) chip selects

ACCESSORIES

- Heatsink, heat spreading plate, development carrier

ENVIRONMENTAL

- 0 °C to 60 °C operating temperature range

COMPLIANCE AND CERTIFICATION INFORMATION

- RoHS 6/6
- UL/CSA 60950-1, EN55022, FCC Class B

Firmware and Operating System Support

OS SUPPORT

- Linux 2.6.34 BSP
- Wind River VxWorks 6.8 AMP and SMP
- Green Hills INTEGRITY

Ordering Information	
Product	Description
COMX-P4040	P4040 processor module
COMX-P4040-4G-KIT	P4040 with 4GB DRAM and heatsink
COMX-P4080	P4080 processor module
COMX-P4080-HP	P4080 heat spreading plate
COMX-P4080-HTSNK	P4080 active heatsink
COMX-P4080-4G-KIT	P4080 with 4GB DRAM and heatsink
COMX-CAR-P1	QorIQ module carrier card
P4080COME-DS-PB	Freescale Development System including the P4080 module, carrier, memory and driver. This kit is available from Freescale and Freescale distributors. For more information go to www.freescale.com













SOLUTION SERVICES

Emerson Network Power provides a portfolio of solution services optimized to meet your needs throughout the product lifecycle. Design services help speed time-to-market. Deployment services include global 24x7 technical support. Renewal services enable product longevity and technology refresh.

COM Express is a trademark of PICMG. All other product or service names are the property of their respective owners.

This document identifies products, their specifications, and their characteristics, which may be suitable for certain applications. It does not constitute an offer to sell or a commitment of present or future availability, and should not be relied upon to state the terms and conditions, including warranties and disclaimers thereof, on which Emerson Network Power may sell products. A prospective buyer should exercise its own independent judgment to confirm the suitability of the products for particular applications. Emerson Network Power reserves the right to make changes, without notice, to any products or information herein which will, in its sole discretion, improve reliability, function, or design. Emerson Network Power does not assume any liability arising out of the application or use of any product or circuit described herein; neither does it convey any license under its patent or other intellectual property rights or under others. This disclaimer extends to any prospective buyer, and it includes Emerson Network Power's licensee, licensee's transferees, and licensee's customers and users. Availability of some of the products and services described herein may be restricted in some locations.

Emerson Network Power.
The global leader in enabling
Business-Critical Continuity™.

-  AC Power
-  Embedded Power
-  Precision Cooling
-  Connectivity
-  Infrastructure Management & Monitoring
-  Racks & Integrated Cabinets
-  DC Power
-  Outside Plant
-  Services
-  Embedded Computing
-  Power Switching & Controls
-  Surge Protection

Emerson Network Power

Offices: Tempe, AZ U.S.A. 1 800 759 1107 or +1 602 438 5720
 Paris, France +33 1 60 92 31 20 • Munich, Germany +44 1509 236490 • Tel Aviv, Israel +972 99560361
 Hong Kong +852 2176 3540 • Shanghai, China +86 21 3395 0289 • Tokyo, Japan +81 3 5403 2730 • Seoul, Korea +82 2 3483 1500

EmersonNetworkPower.com/EmbeddedComputing

Emerson, Business-Critical Continuity and Emerson Network Power are trademarks of Emerson Electric Co. or one of its affiliated companies. ©2011 Emerson Electric Co.