

COMX-P5020

High Performance Freescale QorIQ™ Module

■ Embedded Computing for
Business-Critical Continuity™

PRELIMINARY DATA SHEET

COM Express based module with QorIQ™ processing power for rapid deployment across diverse I/O requirements

- Freescale QorIQ P5020 processor
- Two Power Architecture cores running at 2.0 GHz
- Support for two channels of 2GB DDR3-1333 ECC SO-UDIMM (4GB max.)
- 95 mm x 125 mm COM Express Basic footprint
- 12 configurable SERDES lanes available for maximum flexibility

The COMX-P5020 module from Emerson Network Power provides the performance and features of the Freescale QorIQ™ processors on ready-to-go pluggable mezzanine modules. By incorporating and leveraging the mechanical features and dimensions of the COM Express® specification, the COMX-P5020 exhibit all the best attributes of the COM Express open standard enabling shorter development schedules and faster time-to-market. Emerson has a range of QorIQ based COM Express form factor modules to enable scalable product strategies with multiple performance levels. This open, standardized approach fosters competitive pricing, greater upgrade flexibility and longevity of support.

The QorIQ P5020 processor is effectively a system-on-chip (SOC) device with a range of features including high-performance datapath acceleration and network processing in a low power envelope making the COMX-P5020 modules suitable for combined control, datapath and application layer processing. Underpinning the high-compute capability of these modules are the multiple Power Architecture e500mc cores which are complemented by highly flexible I/O including 10G-XAUI, SRIO, GPIO, USB 2.0, PCI Express, Gigabit Ethernet and real-time debug.

The COMX-P5020 module dimensions are 95 mm x 125 mm which enables it to fit within a very wide range of enclosures when mounted on a customer carrier. It is an off-the-shelf processor solution that isolates you from the complexities of high speed processor and memory system design, allowing you to concentrate on a carrier tailored to application I/O needs.

By combining the tried and tested Power Architecture processor core along with a considerable range of on-module I/O, the COMX-P5020 is suitable for a range of applications including enterprise and service provider routers, switches, base-station controllers, radio network controllers (RNCs), long-term evolution (LTE) and general-purpose embedded computing systems in the networking, telecom/datacom, wireless infrastructure, military and aerospace markets.

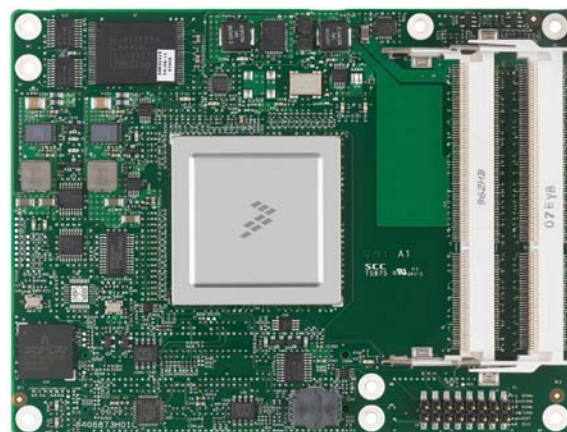

COM  Express®

EMERSON™
Network Power

COMX-P5020 Block Diagram

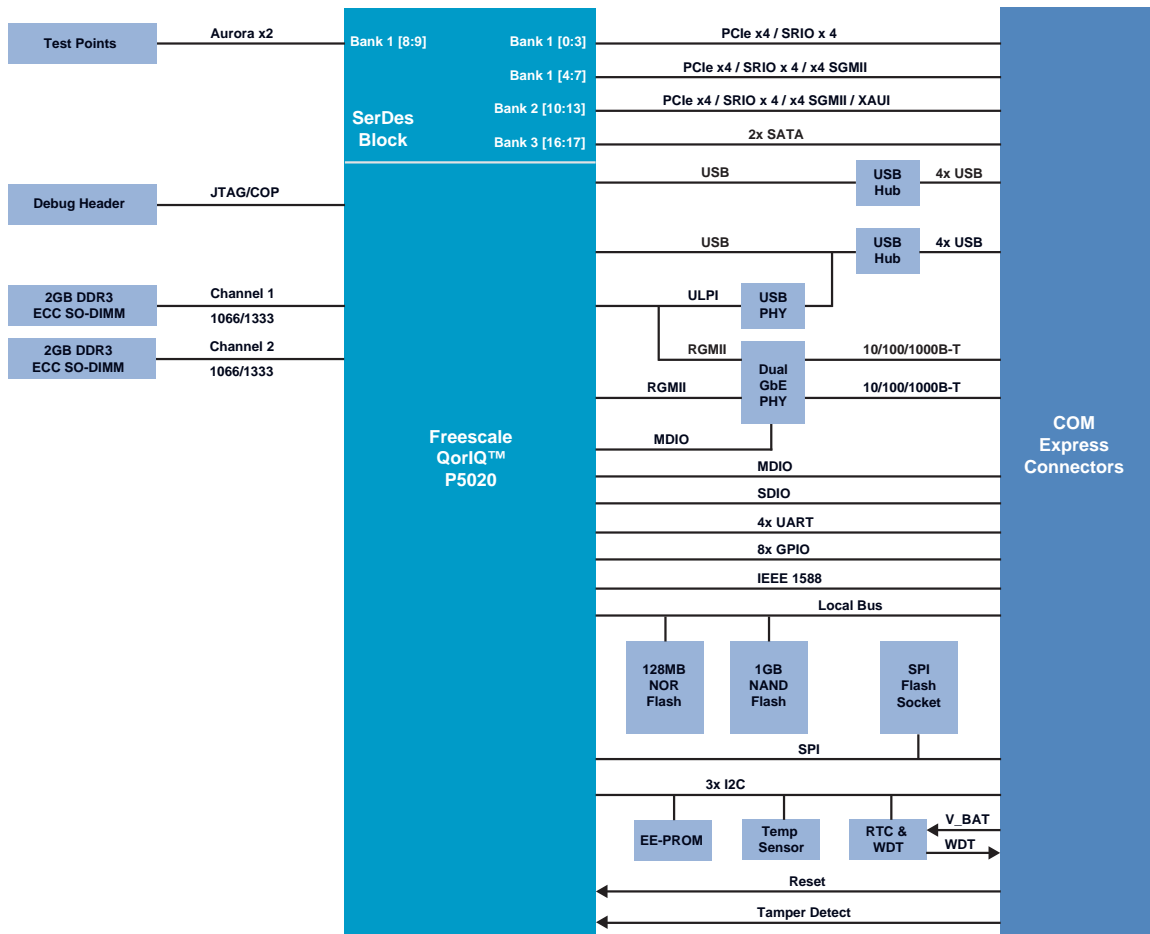

Hardware Specifications

PROCESSOR

- Freescale QorIQ P5020, two cores running at 2.0 GHz

FORM FACTOR

- 95 mm x 125 mm COM Express Basic size

BOOTLOADER

- U-boot

MEMORY

- Support for 4GB DDR3-1333 ECC SO-UDIMM (two channels of 2GB)

ON-BOARD STORAGE

- 128MB NOR flash
- 1GB NAND flash
- 2kilobit EEPROM

ON-BOARD I/O

- JTAG Debug

I/O TO THE CARRIER

12 configurable SERDES lanes available for maximum flexibility in customer platform design. Available interfaces include:

- Up to one (1) 10 GbE XAU1 3.125Gbps
- Up to four (4) 1 GbE SGMII 1.25 Gbps
- Up to three (3) PCI Express (x4) 2.5 or 5Gbps
- Up to two (2) SRIO (4x) 2.5 or 3.125 Gbps

OTHER I/O AT THE CONNECTOR

- Four (4) UART ports
- Two (2) Gigabit Ethernet interface (10/100/1000Base-T)
- Two (2) MDIO
- One (1) SDIO
- Eight (8) general purpose I/O (GPIO) ports
- Three (3) I²C bus
- Five (5) IRQ interrupts
- Eight (8) USB 2.0 ports
- Two (2) SATA II ports
- IEEE 1588 control
- Tamper detection
- Real-time clock
- Watchdog timer
- SPI Bus with four (4) chip selects

ACCESSORIES

- Heatsink, heat spreading plate, development carrier

ENVIRONMENTAL

- 0 °C to 60 °C operating temperature range

COMPLIANCE AND CERTIFICATION INFORMATION

- RoHS 6/6
- UL/CSA 60950-1, EN55022, FCC Class B

Firmware and Operating System Support

OS SUPPORT

- Linux 2.6.34 BSP
- Wind River VxWorks 6.8 AMP and SMP
- Green Hills INTEGRITY

Ordering Information	
Product	Description
COMX-P5020	P5020 processor module
COMX-P5020-4G-KIT	P5020 with 4GB DRAM and heatsink
COMX-CAR-P1	QorIQ module carrier card













SOLUTION SERVICES

Emerson Network Power provides a portfolio of solution services optimized to meet your needs throughout the product lifecycle. Design services help speed time-to-market. Deployment services include global 24x7 technical support. Renewal services enable product longevity and technology refresh.

COM Express is a trademark of PICMG. All other product or service names are the property of their respective owners.

This document identifies products, their specifications, and their characteristics, which may be suitable for certain applications. It does not constitute an offer to sell or a commitment of present or future availability, and should not be relied upon to state the terms and conditions, including warranties and disclaimers thereof, on which Emerson Network Power may sell products. A prospective buyer should exercise its own independent judgment to confirm the suitability of the products for particular applications. Emerson Network Power reserves the right to make changes, without notice, to any products or information herein which will, in its sole discretion, improve reliability, function, or design. Emerson Network Power does not assume any liability arising out of the application or use of any product or circuit described herein; neither does it convey any license under its patent or other intellectual property rights or under others. This disclaimer extends to any prospective buyer, and it includes Emerson Network Power's licensee, licensee's transferees, and licensee's customers and users. Availability of some of the products and services described herein may be restricted in some locations.

Emerson Network Power.
The global leader in enabling
Business-Critical Continuity™.

-  AC Power
-  Embedded Power
-  Precision Cooling
-  Connectivity
-  Infrastructure Management & Monitoring
-  Racks & Integrated Cabinets
-  DC Power
-  Outside Plant
-  Services
-  **Embedded Computing**
-  Power Switching & Controls
-  Surge Protection

Emerson Network Power

Offices: Tempe, AZ U.S.A. 1 800 759 1107 or +1 602 438 5720
 Paris, France +33 1 60 92 31 20 • Munich, Germany +44 1509 236490 • Tel Aviv, Israel +972 99560361
 Hong Kong +852 2176 3540 • Shanghai, China +86 21 3395 0289 • Tokyo, Japan +81 3 5403 2730 • Seoul, Korea +82 2 3483 1500

EmersonNetworkPower.com/EmbeddedComputing

Emerson, Business-Critical Continuity and Emerson Network Power are trademarks of Emerson Electric Co. or one of its affiliated companies. ©2011 Emerson Electric Co.