

**NuIPC<sup>â</sup>**

**cPCIS-1000/2000 Series: 3U CompactPCI  
Sub-systems and Components**

**User's Guide**



Recycled Paper

This user's manual includes the information for the following products range:

***Sub-systems: (Single System with LCD)***

- cPCIS-2150: 3U CompactPCI Platform with LCD and Off-the-Shelf ATX PSU
- cPCIS-2151: 3U CompactPCI Platform with LCD and Universal AC PSU
- cPCIS-2152: 3U CompactPCI Platform with LCD and Dual Redundant AC PSU
- cPCIS-1151: 3U CompactPCI Platform with LCD and Universal AC PSU

***Sub-systems: (Single System without LCD)***

- cPCIS-2100: 3U CompactPCI Platform with Off-the-Shelf ATX PSU
- cPCIS-2102: 3U CompactPCI Platform with Dual Redundant AC PSU
- cPCIS-1100: 3U CompactPCI Platform with Off-the-Shelf ATX PSU

***Sub-systems: (Dual System)***

- cPCIS-1250: 3U CompactPCI Platform with Dual System

***Components for 3U System***

- ◆ Power supply options:
  - cPS-150R: 3U 175W 31-pin redundant power supply unit
  - cPS-175/AC: 3U 175W 47-pin Universal AC input redundant PSU
  - cPS-175/48: 3U 175W 47-pin Universal AC input redundant PSU
  - cPS-175/25: 3U 175W 47-pin Universal AC input redundant PSU
  - cPCI-PSF: Power supply frame for holding PS2-size power supply
  - APS-925A: 280W ATX power supply
- ◆ Backplane options:
  - cBP-3400 Series: 3U 64-bit CompactPCI backplane
  - cBP-3100 Series: 3U 32-bit CompactPCI backplane
  - cBP-3200 Series: 3U 32-bit CompactPCI backplane with rear I/O
  - cBP-3052/3051: Backplane for single/dual 31-pin 3U redundant power supply
  - cBP-3062: Backplane for dual 47-pin 3U redundant power supply

◆ LCD Kit:

- cPCI-LCD: High brightness 6.4" LCD Kit

◆ Mechanical parts:

- cPCI-PSF: Power supply frame for holding PS2-size power supply
- cPCI-DBF: Drive bay frame for the drive bay



©Copyright 2000 ADLINK Technology Inc.  
All Rights Reserved.

Manual Rev. 1.02: August 30, 2000

The information in this document is subject to change without prior notice in order to improve reliability, design and function and does not represent a commitment on the part of the manufacturer.

In no event will the manufacturer be liable for direct, indirect, special, incidental, or consequential damages arising out of the use or inability to use the product or documentation, even if advised of the possibility of such damages.

This document contains proprietary information protected by copyright. All rights are reserved. No part of this manual may be reproduced by any mechanical, electronic, or other means in any form without prior written permission of the manufacturer.

### **Trademarks**

NuIPC is a registered trademark of ADLINK Technology Inc.

Other product names mentioned herein are used for identification purposes only and may be trademarks and/or registered trademarks of their respective companies.

# Getting service from ADLINK

- ◆ Customer Satisfaction is always the most important thing for ADLINK Tech Inc. If you need any help or service, please contact us and get it.

ADLINK Technology Inc.			
Web Site	http://www.adlink.com.tw http://www.adlinktechnology.com		
Sales & Service	service@adlink.com.tw		
Technical Support	NuDAQ	nudaq@adlink.com.tw	
	NuDAM	nudam@adlink.com.tw	
	NuIPC	nuipc@adlink.com.tw	
	NuPRO	nupro@adlink.com.tw	
	Software	sw@adlink.com.tw	
TEL	+886-2-82265877	FAX	+886-2-82265717
Address	9F, No. 166, Jian Yi Road, Chungho City, Taipei, 235 Taiwan, R.O.C.		

- ◆ Please inform or FAX us of your detailed information for a prompt, satisfactory and constant service.

Detailed Company Information			
Company/Organization			
Contact Person			
E-mail Address			
Address			
Country			
TEL		FAX	
Web Site			
Questions			
Product Model			
Environment to Use	OS _____ Computer Brand _____ M/B: _____ CPU: _____ Cipset: _____ BIOS: _____ Video Card: Network Interface Card: Other:		
Challenge Description			
Suggestions for ADLINK			

# Table of Contents

<b>How to Use This Manual</b> .....	<b>iv</b>
<b>Chapter 1 Introduction</b> .....	<b>1</b>
<b>Chapter 2 Chassis</b> .....	<b>3</b>
2.1    cPCIS-2000 Chassis .....	3
2.1.1 <i>Features</i> .....	3
2.1.2 <i>Mechanical Drawing</i> .....	4
2.1.3 <i>Specifications</i> .....	4
2.2    cPCIS-1000 Chassis .....	6
2.2.1 <i>Specifications</i> .....	6
2.2.2 <i>Mechanical Drawing</i> .....	6
2.3    3U Power Supply Frame cPCI-PSF .....	7
2.3.1 <i>Introductions</i> .....	7
2.3.2 <i>Features</i> .....	7
2.3.3 <i>Mechanical Drawing</i> .....	7
2.4    3U Drive Bay Frame cPCI-DBF .....	8
2.4.1 <i>Introductions</i> .....	8
2.4.2 <i>Features</i> .....	8
2.4.3 <i>Mechanical Drawing</i> .....	8
2.5    3U 4HP slot-panel with EMC gasket cPCI-SP3E .....	8
<b>Chapter 3 Power Supply Unit</b> .....	<b>9</b>
3.1    cPS-150R .....	10
3.1.1 <i>Introduction</i> .....	10
3.1.2 <i>The Outline of Power Supply</i> .....	10
3.1.3 <i>Installation</i> .....	11
3.1.4 <i>Specifications</i> .....	11
3.1.5 <i>Connector Pin Assignments</i> .....	14
3.2    cPS-175 Series Power Supply Unit .....	17
3.2.1 <i>Introduction</i> .....	17
3.2.2 <i>The Outline of Power Supply</i> .....	17
3.2.3 <i>Installation</i> .....	17
3.2.4 <i>Specifications</i> .....	18
3.2.3 <i>Connector Pin Assignments</i> .....	21
3.3    APS-925AX: 280 ATX Power Supply .....	25
3.3.1 <i>Introductions</i> .....	25
3.3.2 <i>Specifications</i> .....	25

**Chapter 4 3U Backplane.....28**

4.1 cBP-3400 Series ..... 29  
4.1.1 Features..... 29  
4.1.2 Products List..... 29  
4.1.3 PCB Drawing..... 30  
4.1.4 Specifications..... 30  
4.1.5 Connectors pin assignments ..... 30  
4.2 cBP-3100 Series ..... 33  
4.3 cBP-3200 Series ..... 34  
4.3.1 Features..... 34  
4.3.2 Products List..... 34  
4.3.3 PCB Drawing..... 35  
4.3.4 Connectors pin assignments ..... 36  
4.4 cBP-3052E Backplane ..... 39  
4.4.1 Specifications..... 39  
4.4.2 PCB Drawing..... 39  
4.4.4 Connectors pin assignments ..... 39  
4.5 cBP-3051..... 41  
4.5.1 Specifications..... 41  
4.5.2 PCB Drawing..... 41  
4.5.3 Connectors pin assignments ..... 41  
4.6 cBP-3062 Backplane..... 43  
4.6.1 Specifications..... 43  
4.6.2 PCB Drawing..... 43  
4.6.3 Connectors pin assignments ..... 43

**Chapter 5 LCD Kit .....45**

5.1 Features ..... 45  
5.2 Mechanical Drawing..... 45  
5.3 Specifications..... 46  
5.4 Connectors Pin Assignment ..... 47

**Chapter 6 cPCIS-2000 Sub-systems.....49**

6.1 cPCIS-2150 Series..... 50  
6.1.1 Features..... 50  
6.1.2 Configurations..... 50  
6.1.3 Ordering Options ..... 51  
6.2 cPCIS-2151 Series..... 52  
6.2.1 Features..... 52  
6.2.2 Configurations..... 52  
6.2.3 Ordering Options ..... 52  
6.3 cPCIS-2100 Series..... 54  
6.3.1 Features..... 54



	6.3.2	Configurations.....	54
	6.3.3	Ordering Options .....	55
6.4		cPCIS-2102 Series.....	56
	6.4.1	Features.....	56
	6.4.2	Configurations.....	56
	6.4.3	Ordering Options .....	56
6.5		cPCIS-2152 Series.....	58
	6.5.1	Features.....	58
	6.5.2	Configuration.....	58
	6.5.3	Ordering Options .....	58
<b>Chapter 7 cPCIS-1000 Sub-systems.....</b>			<b>60</b>
7.1		cPCIS-1151 .....	61
	7.1.1	Features.....	61
	7.1.2	Configurations.....	61
	7.1.3	Ordering Options .....	61
7.2		cPCIS-1100 Series.....	62
	7.2.1	Features.....	62
	7.2.2	Configurations.....	62
	7.2.3	Ordering Options .....	62
7.3		cPCIS-1250 .....	64
	7.3.1	Features.....	64
	7.3.2	Configurations.....	64
	7.3.3	Ordering Options .....	64
<b>Product Warranty/Service.....</b>			<b>65</b>

# How to Use This Manual

This manual is designed to help you use the cPCI-2000/1000 Series 3U CompactPCI Sub-system. It is divided into five chapters:

- ◆ **Chapter 1**, "Introduction," gives an overview of the product features.
- ◆ **Chapter 2**, "Chassis," describes the specifications and installation of the chassis.
- ◆ **Chapter 3**, "Power Supply," describes the using of power supply.
- ◆ **Chapter 4**, "Backplane", describes the backplane specifications.
- ◆ **Chapter 5**, "LCD Kit", describes the specifications of 6.4" LCD kit.
- ◆ **Chapter 6**, "Sub-system", describes the specifications of sub-systems.

# Introduction

This users manual gives you the following information about the cPCI-2000 series 3U CompactPCI sub-systems, including the brief introduction of the components and the detail specifications of the sub-systems.

The cPCI-2000 series sub-systems are assembling by the following major components:

## **Components:**

- ◆ Chassis options:
  - cPCIS-1000: 3U CompactPCI card cage
  - cPCIS-2000A: 3U CompactPCI chassis with 2 Fans
  - cPCIS-2000B: 3U CompactPCI chassis with 4 Fans
  - cPCI-PSF: Power supply frame for holding PS2-size power supply
  - cPCI-DBF: Drive bay frame for the drive bay
- ◆ Power supply options:
  - cPS-150R: 3U 175W 31-pin redundant power supply unit
  - cPS-175/AC: 3U 175W 47-pin Universal AC input redundant PSU
  - cPS-175/48: 3U 175W 47-pin Universal AC input redundant PSU
  - cPS-175/25: 3U 175W 47-pin Universal AC input redundant PSU
  - APS-925A: 280W ATX power supply
- ◆ Backplane options:
  - cBP-3400 Series: 3U 64-bit CompactPCI backplane
  - cBP-3100 Series: 3U 32-bit CompactPCI backplane

- cBP-3200 Series: 3U 32-bit CompactPCI backplane with rear I/O
- cBP-3052/3051: Backplane for single/dual 31-pin 3U redundant power supply
- cBP-3062: Backplane for dual 47-pin 3U redundant power supply

◆ LCD Kit:

- cPCI-LCD: High brightness 6.4" LCD kit

We also provide sub-systems based on the above optional components. Whenever the sub-systems cannot fully meet users' requirement, please contact with us for discussing the possibility for more options. To form a complete starting kit, users need to order other CPU modules, which are not specified here.

***Sub-systems: (Single System with LCD)***

- cPCIS-2150: 3U CompactPCI Platform with LCD and Off-the-Shelf ATX PSU
- cPCIS-2151: 3U CompactPCI Platform with LCD and Universal AC PSU
- cPCIS-2152: 3U CompactPCI Platform with LCD and Dual Redundant AC PSU
- cPCIS-1151: 3U CompactPCI Platform with LCD and Universal AC PSU

***Sub-systems: (Single System without LCD)***

- cPCIS-2100: 3U CompactPCI Platform with Off-the-Shelf ATX PSU
- cPCIS-2102: 3U CompactPCI Platform with Dual Redundant AC PSU
- cPCIS-1100: 3U CompactPCI Platform with Off-the-Shelf ATX PSU

***Sub-systems: (Dual System)***

- cPCIS-1250: 3U CompactPCI Platform with Dual System

The following chapters will describe the specifications of the above components or sub-systems.

# 2

## Chassis

In this chapter, we will describe the detail features and specifications of the cPCIS-1000 and cPCIS-2000 chassis. Other mechanical parts which may be used to assembly the system also be described.

---

### 2.1 cPCIS-2000 Chassis

#### 2.1.1 Features

- ◆ Standard 19" 3U CompactPCI form factor, 4U in height
- ◆ Boards Space:
  - Board space for I/O, CPU and power supply is standard 3U height, 21-slot width
  - Both front access or rear access are possible
  - With versatile backplane options, can assembly to many sub-systems with different configurations
- ◆ Two (or four) built-in pushing fans are used for self-cooling system. All fans and air-filter are removable on the bottom side
- ◆ Suitable for both rack-mount and desktop applications
  - Side handle are designed for portable instrument
  - Two adjustable foot stands are designed for desktop applications
- ◆ Comprehensive EMC shielding: EMC gaskets are installed on the front rails (up and down), rear rails and the side panels

## 2.1.2 Mechanical Drawing

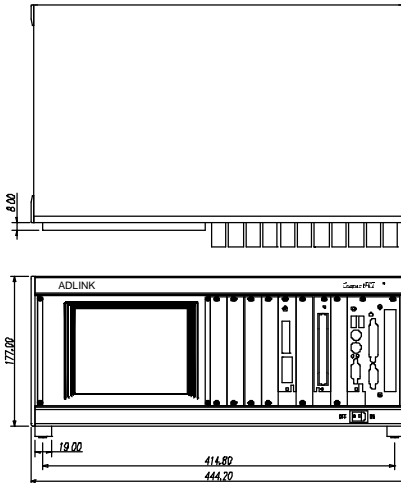

**Note:** This drawing is for showing the mechanical dimension only, the components inside the chassis is dependent on every different model number.

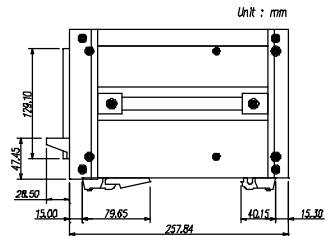

## 2.1.3 Specifications

- ◆ Dimension: 444.2(W) mm x 177(H) mm x 257.9(D) mm

**Note :** 1. Width is 482.6 mm (19") with rack-mounting kit.  
2. 177.0 mm is to fit 4U height. Total height is 189.1 mm with foot stands.

- ◆ Usable width: 21 slots (84HP)
- ◆ Internal pushing FAN on the bottom:
  - Fan type: DC brushless motor
  - Numbers of FAN:
    - 2 Fans for cPCIS-2000A
    - 4 Fans for cPCIS-2000B
  - Rated voltage: 12V @ 0.43A (use -12V of system power)
  - Input Power: 5.16W (rated); 7.7W (maximum)
  - Maximum Air flow: 60 CFM (when zero static pressure)
  - Operating Temperature: -10 ~ 70 degree C
- ◆ Internal FAN controller:
  - Designed to utilize the system -12V for FAN power

- Current control of the FAN to provide stable fan operation
- Fan failure detection ready to use
- Power input connector (CN101)

Pin #	Signal	Cable color
1	-12V	Yellow
2	GND	Black
3	+5V	Red

- Connector to Fans (CN102)

Pin #	Signal
1	GND
2	Fan #1 power
3	GND
4	Fan #2 power
5	GND
6	Fan #3 power
7	GND
8	Fan #4 power

- Fan failure output (CN103)

Pin #	Signal
1	+5V
2	Fan #1 failure output
3	Fan #2 failure output
4	Fan #3 failure output
5	Fan #4 failure output

- Power requirement:
  - +5V: 40 mA maximum
  - -12V: 200 mA plus fans' power consumption, which is dependent on numbers of fans

---

## 2.2 cPCIS-1000 Chassis

### 2.2.1 Specifications

- ◆ 19" rack-mount 3U in height, 21-slot CompactPCI card cage
- ◆ Need external fan for cooling
- ◆ Dimension: 482.56 (W) mm x 133.35 (H) mm x 250.0 (D) mm

### 2.2.2 Mechanical Drawing

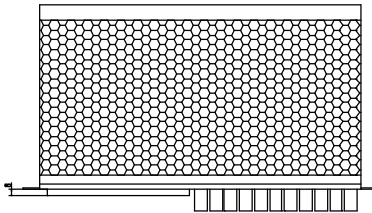

**Note:** This drawing is for showing the mechanical dimension only, the components inside the chassis is dependent on every different model number.

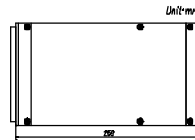
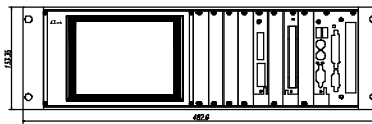



---

## 2.3 3U Power Supply Frame cPCI-PSF

### 2.3.1 Introductions

The cPCI-PSF is a power supply frame, which is designed for holding the PS2 size power supply in a 3U CompactPCI card cage. Four standard card guides are necessary for guiding the position of this frame. Any PS2 sized power supply unit can be used together with cPCI-PSF.

### 2.3.2 Features

- ◆ To fit standard 3U CompactPCI form factor with 9-slot (36HP) width. Dimension: 182.6 mm x 128.7 mm x 94.5 mm
- ◆ Any standard PS2 sized power supply unit can be fit
- ◆ Rugged mechanical design, the frame is held on the standard card guide position

### 2.3.3 Mechanical Drawing

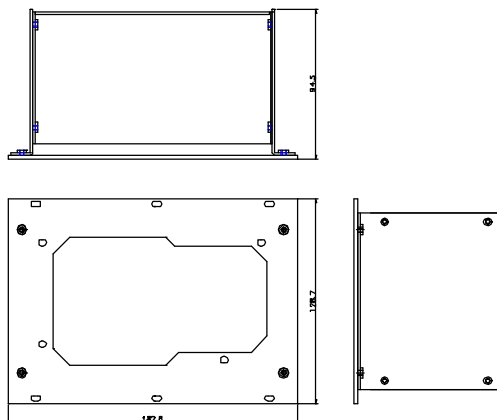

---

## 2.4 3U Drive Bay Frame cPCI-DBF

### 2.4.1 Introductions

The cPCI-DBF is a drive bay frame, which is designed for holding the FDD, HDD or CD-ROM drives in a 3U CompactPCI card cage. The drive bay can support two 5 1/4" drives and one 3 1/2" drive.

### 2.4.2 Features

- ◆ To fit standard 3U CompactPCI form factor with 10-slot (40HP) width. Dimension: 202.9 (W) mm x 128.7 (H) mm x 172.5. (D) mm
- ◆ Support two 5 1/4" drives and one 3 1/2" drive
- ◆ Rugged mechanical design

### 2.4.3 Mechanical Drawing

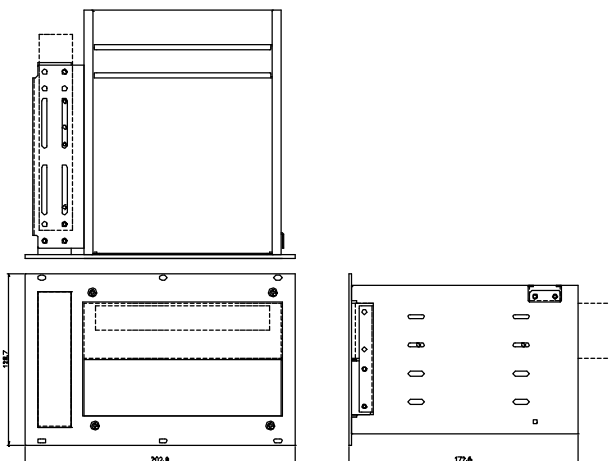

---

## 2.5 3U 4HP slot-panel with EMC gasket cPCI-SP3E

The 3U CompactPCI chassis are shipped with the slot-panel, which is without EMC spring. Users can order the cPCI-SP3E, which is a U-shaped 4HP width slot-panel with the EMI spring. To use cPCI-SP3E on the blank slots is necessary for EMI shielding.

# 3

## Power Supply Unit

The power supply unit in the 3U CompactPCI system is with modular design. The users can chose the most suitable solution for the specified applications. There are many kinds of power supply unit can be installed in 3U CompactPCI card cage. In this chapter, the features and specifications of the following power supply unit or modules are shown.

- ◆ Redundant Power Supply
  - cPS-150R: 3U 175W universal AC input redundant power supply (31-pin)
  - cPS-175/AC: 3U 175W universal AC input redundant power supply (47-pin)
  - cPS-175/48: 3U 175W –48V DC input redundant power supply (47-pin)
  - cPS-175/24: 3U 175W –24V DC input redundant power supply (47-pin)
- ◆ PS2-size Power Supply
  - APS-925A: 280W Auto-switched AC input ATX Power Supply



### 3.1.3 Installation

After inserting cPS-150R to a standard 3U CompactPCI system or the standard 6U CompactPCI system, you can turn on the switch on the chassis. Of course, you may turn on the power switch on the chassis first, and insert cPS-150R, which delivers full safety redundant, hot-swappable function, and provides the plug-able feature.

#### WARNING

Be sure that the socket of the backplane on the chassis is ERNI part #914374; AMP#148370-1 or #97-7200 defined by PICMG before inserting cPS-150R to the chassis. If cPS-150R is forcibly inserted, it and the connector of the chassis will be damaged.

### 3.1.4 Specifications

#### ◆ AC Input

Item	Specification	Test Conditions
Operating Voltage	90 - 264 Vac, single phase	
Input current	3.1 A max	
Inrush current	<40A	@ 240 Vac
Frequency range	45-440 Hz	
Power factor	0.99 typical	
Efficiency	typical 73%	
Protection	over current, over voltage, under voltage, and surge protection.	

#### ◆ DC Output

Item	Specification	Test Conditions
Output power	175W max.	For working area refer to figure 3.1.4
Output voltage	+5V, +3.3V, +12V, -12V	
Output current	20A @+5V ( <b>2A min.</b> ) 12A @+3.3V 2A @+12V 1A @-12V	
Voltage error	< ±3% @+5V < ±5% @+3.3V < ±5% @+12V < ±5% @-12V	

Ripple voltage	+5V..... 1.0 % p-p +3.3V..... 1.5 % p-p +12V..... 1.0 % p-p -12V ..... 1.0 % p-p	The testing probe must be in parallel with a capacitor of 22 $\mu$ F and that of 0.1 $\mu$ F.
Current sharing in parallel	Any number of power supplies can be operated in parallel and will share current to within 10%	only at +5V output
Load regulation	The output voltage of +5V changes within $\pm$ 3% of allowed value.	Input voltage is from 90Vac to 260Vac. Load is from 10% to 100%.
Line regulation	The output voltage of +5V changes within $\pm$ 0.1% of allowed value.	Input voltage is from 90Vac to 260Vac. Load is from 10% to 100%.
Hold up time	>6ms	
Rising time	<200ms	
Temperature coefficient	0.05% / $^{\circ}$ C	
Protection	All outputs protected against overload and short circuit. Straightline current limiting, does not fold-back or latch-up during startup or load transients. Automatic recovery. Shutdown at internal heatsink temperature of 95 $^{\circ}$ C. Automatic recovery. Shutdown at the output voltage exceeds the nominal voltage 20%. Recycle power to reset.	

◆ **Others**

Item	Specification	Test Conditions
Input/output connector	Male base is on the rear of power supply, and must meet IEC 603-2 (DIN 41612) or IEC 1076.	
Indicator	Normal (green LED) Fail (red LED)	
Switching frequency	100KHz	
MTBF	50,000 hours	MIL-HDBK-217E
MTTR	5 minutes	
EMC	meets FCC and Class A of VDE	
Safety specification	UL 1950, CSA C22.2 NO.950, EN60950/ TÜV	
CE	EMI: EN61000-3-2(1995), EN61000-3-3 harmonics	

	meets EN55022 Class A EMS:EN 50082-2 EN61000-4-2 EN61000-4-3 EN61000-4-4 EN61000-4-6 EN61000-4-8 ENV 50204	
Impact & vibration test	Frequency Range: 5Hz – 35Hz 5 min 35Hz – 55Hz 5 min 55Hz – 5Hz 5 min Displacement: 0.38mm Dweep time: 30 minutes for each axis Duration: 2 cycles for three orthogonal axis. Axis: X, Y, Z	Unpackaged, Non-operating
Insulating strength	Primary - secondary: 4242Vrms Primary - chassis ground: 3050Vrms secondary - chassis ground: 500Vrms	
Output insulation	Relatively to chassis ground, all control signals and outputs are floating SELV circuits.	
Operation temperature	0°C~70°C(the temperature on the chassis) Full power from 0°C to 40°C with 15 cfm forced air flow	
Storing temperature	- 40°C to +85°C	
Relative humidity	<95% @ 40°C, none condensation	
Operation height	6,400m	
Weight	about 0.85Kg	

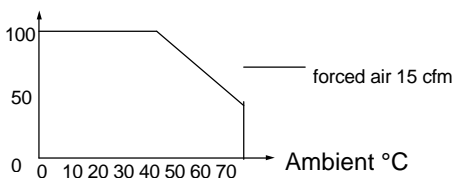

**Figure 3.1.4 Working Area**

### 3.1.5 Connector Pin Assignments

Pin # <sup>(1)</sup>	Staging <sup>(2)</sup>	Mnemonic	Description
<b>Column A</b>			
A13	EL	SP	Spare
A14	EL	INH#	Inhibit Signal
A15	EL	ISH	Current Share Signal
A16	EL	5S-	5V Sense -
A17	EL	5S+	5V Sense +
A18	EL	3.3V	+3.3 VDC
A19	EL	+12V	+12 VDC
A20	EL	-12V	-12 VDC
<b>Column B</b>			
B2	SL	ACL	AC Line
B5	SL	ACN	AC Neutral
B8	-	-	No Pin Loaded
B11	EL	CG <sup>(3)</sup>	Chassis Ground
B13-18	SL	3.3V	+3.3 VDC
B19	SL	+12V	+12 VDC
B20	SL	-12V	-12 VDC
B22	EL	5V	+5 VDC
B25	EL	GND	Ground
B28	EL	+DC	+DC Input
B31	EL	-DC	-DC Input
<b>Column C</b>			
C13	SL	EN#	Enable Signal
C14	SL	DEG#	Derate Signal
C15	SL	FAL#	Supply Fail Signal
C16-18	SL	3.3V	+3.3 VDC
C19	SL	+12V	+12 VDC
C20	SL	-12V	-12 VDC

- Note:**
1. Mating pin numbers on power supply connector.
  2. EL is an Extra Length pin. SL is a Standard Length pin.
  3. CG must be connected to earth ground.
  4. **Mating Connector (top view)** Pin numbers illustrated are the pin view of the female mating connector. A mating connector is ERNI part #914374; AMP #148370-1 or #97-7200-016.



## Definitions of Pin Signals

Signal	Definition															
<b>INH#</b>	<p><i>Inhibit</i> signal <b>MAY</b> be used to “turn off” the power supply outputs. This signal is on a longer pin than the EN#(enable) signal and therefore has precedence over the EN# signal when determining power supply operation (see table below). The INH# signal is typically connected to an “ON/OFF” switch. This signal is optional.</p> <p>Module Power Supply Operation</p> <table border="1"> <tr> <td><b>INH# =</b></td> <td>Low</td> <td>Low</td> <td>High</td> <td>High</td> </tr> <tr> <td><b>EN# =</b></td> <td>Low</td> <td>High</td> <td>Low</td> <td>High</td> </tr> <tr> <td><b>Power Status</b></td> <td>“OFF”</td> <td>“OFF”</td> <td>“ON”</td> <td>“OFF”</td> </tr> </table>	<b>INH# =</b>	Low	Low	High	High	<b>EN# =</b>	Low	High	Low	High	<b>Power Status</b>	“OFF”	“OFF”	“ON”	“OFF”
<b>INH# =</b>	Low	Low	High	High												
<b>EN# =</b>	Low	High	Low	High												
<b>Power Status</b>	“OFF”	“OFF”	“ON”	“OFF”												
<b>ISH</b>	<i>Current Share</i> signal <b>MAY</b> be used between multiple power supplies for load balancing. This signal is not required for single power supply systems.															
<b>5S-</b>	<i>5V Sense -</i> <b>SHALL</b> be connected to the center of the ground plane for accommodating power distribution losses. This signal is required for all modular power supplies.															
<b>5S+</b>	<i>5V Sense +</i> <b>SHALL</b> be connected to the center of the power plane for accommodating power distribution losses. This signal is required for all modular power supplies.															
<b>ACL</b>	<i>AC Line</i> input <b>SHALL</b> be used for supplies operating from AC. This input is not required for DC input power supplies. Separate AC and DC inputs are provided to prevent damaging an AC power supply inserted into a backplane wired for DC and visa versa.															
<b>ACN</b>	<i>AC Neutral</i> input <b>SHALL</b> be used for supplies operating from AC. This input is not required for DC input power supplies.															
<b>+DC</b>	<i>Positive DC</i> input <b>SHALL</b> be used for supplies operating from DC. This input is not required for AC input power supplies. Separate AC and DC inputs are provided to prevent damaging a DC power supply inserted into a backplane wired for AC and visa versa.															
<b>- DC</b>	<i>Negative DC</i> input <b>SHALL</b> be used for supplies operating from DC. This input is not required for AC input power supplies.															
<b>EN#</b>	<i>Enable</i> signal <b>MAY</b> be used to “turn on” the power supply outputs. EN# is used in conjunction with INH# (see table of INH#) and is typically connected to ground to enable the power supply after signals on longer pins have made contact. This signal is optional.															
<b>DEG#</b>	<i>Derating</i> signal <b>MAY</b> be used as an output from the power supply to indicate that the supply is beginning to derate its power output. This signal is optional. Note that backplanes providing a modular power supply connector shall connect DEG# to the backplane signal DEG# in the event that a power supply implementing this signal is installed.															
<b>FAL#</b>	<i>Supply Fail</i> signal <b>MAY</b> be used as an output from the power supply to indicate that it has failed. This signal is optional. Note that backplanes providing a modular power supply connector shall connect FAL# to the backplane signal FAL# in the event that a power supply implementing this signal is installed.															

---

**Caution:** Improperly connected 5S+ and 5S- leads may damage the power supply.

---

---

## 3.2 cPS-175 Series Power Supply Unit

### 3.2.1 Introduction

cPS-175 series products are a power supply designed for CompactPCI standard industrial computer. Based on the CompactPCI standard design, it has hot-swappable function, and can make the output current shared in parallel. It provides good quality power and instant maintenance to a system. They are compliant with the PICMG 2.11 specifications.

### 3.2.2 The Outline of Power Supply

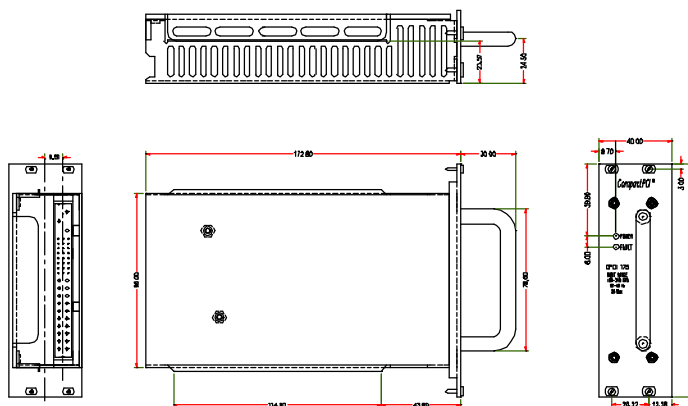

### 3.2.3 Installation

After installing the cPS-175 power supply to a CompactPCI 3U/6U chassis, you can turn on the power switch on the chassis. You may also turn on the power switch on the chassis first, then install the power supply as it has full safety redundant, hot-swappable function and pluggable feature.



**Warning :** Be sure that the backplane socket on the chassis is Positronic part PCIH47F300A1, PCI47F300A1 which is defined by PICMG 2.11 before installing cPS-175 series power supply to the chassis. It could damage the power supply unit and the chassis connector if it is installed forcibly.

---

There are two external warning LEDs.

**POWER:** The Power LED is lit green if the AC or DC external power input power has been turned on.

**FAULT:** If LED is with light, it indicates that the power unit is defective. It means the input voltage is out of the range, or over temperature, over current, or short circuit.

### 3.2.4 Specifications

#### Input

Item	cPS-175/AC	cPS-175/48	cPS-175/24
Voltage	90 – 264 Vac	36 – 72 V <sub>DC</sub>	18 - 36 V <sub>DC</sub>
Input Current	<5A	<9A	<20A
Inrush Current	<40A @ 240V AC	<40A	<40A
Frequency	50 – 60 Hz		
Power Factor	0.99 typical		
Efficiency	Typical 73%	Typical 73%	Typical 73%
Protection	Fuse, Over Voltage, Under Voltage, Surge Protection Note: Current = 5A max. Voltage: 270 Vmax 85Vmin.	Fuse, Over Voltage, Under Voltage, Surge Protection Note: Current = 10A max. Voltage: 75 Vmax. 35 Vmin.	Fuse, Over Voltage, Under Voltage, Surge Protection Note: Current = 20 A max. Voltage: 40 Vmax. 16 Vmin.

#### Output

Item	cPS-175/AC	cPS-175/48	cPS-175/24
Rated Power	175W maximum	175W maximum	175W maximum
Voltage	+5V, +3.3V, +12V, -12V		
Current	25A @ +5V <sup>1</sup> 25A @ +3.3V 3A @ +12V 1A @ -12V Combined current @ +5V & +3.3V < 27A		
Voltage Error	< ±3% @ +5V < ±5% @ +3.3V < ±5% @ +12V < ±5% @ -12V		
Ripple Voltage	100mV or 1 % whichever is greater		
Current Sharing	Any number of power supplies can be operated in parallel and will share +5V and +3.3V current to within 10%.		
Load regulation	±1% @ +5V ±3% @ +3.3V / +12 V / -12V		
Line regulation	±0.3%		
Hold-up time	> 6ms		
Rise time	< 500ms from AC/DC power up. All output voltages come up within 10 msec of each other.		

Temperature Coefficient	0.05% / °C
Protection	<ol style="list-style-type: none"> <li>1. All outputs protected against overload and short circuit. Straightline current limiting, does not fold-back or latch-up during startup or load transients. Automatic recovery.</li> <li>2. Shutdown at internal heatsink temperature of 95°C. Automatic recovery.</li> <li>3. Shutdown at the output voltage exceeds the nominal voltage 20%. Recycle power to reset.</li> </ol>

### Other

Item	cPS-175/AC	cPS-175/48	cPS-175/24
Output/Input Connector	Positronic PCI47M400A1		
Indicator	Green LED indicating INPUT O.K. Red LED indicating a power supply FAULT.		
Switching Frequency	100kHz		
MTBF	100,000hr (by part counting MIL-HDBK0217E)		
MTTR	5 Minutes (based on module replacement)		
Safety	TUV/VDE EN60950 UL		
CE	EMI: EN55022 Class A radiated and conducted EMS: EN 50082-2 (IEC1000-4-2, IEC1000-4-4, IEC-4-5, IEC1000-4-11)		
Shock & Vibration	Frequency range: 5Hz~35Hz (5 min); 35~55Hz (5 min); 55~5Hz(5 min) Displacement: 0.38 mm Dweep time: 30 mins for each axis (X,Y,Z) duration 2 cycles for the three orthogonal axis		
Insulation	Primary – Secondary: 3050Vrms Primary – Chassis Ground: 3050Vrms Secondary – Chassis Ground: 500Vrms	Primary – Secondary: 1150Vrms Primary – Chassis Ground: 500Vrms Secondary – Chassis Ground: 500Vrms	Primary – Secondary: 1150Vrms Primary – Chassis Ground: 500Vrms Secondary – Chassis Ground: 500Vrms
Output Insulation	Floating & SELV		
Operating Temperature	0°C~ 70°C(the temperature on the chassis) Full power from 0°C to 40°C with 15 cfm forced air flow		
Storage Temperature	-10°C ~+85°C		
Humidity	< 95% @ 40°C		
Altitude	6,400m		
Dimension	40.0 (W)× 128.5(H) × 172.8(D) mm		
Weight	about 0.85kg		

**Note** : minimal load 2 A @ +5V is required.

## Operating Area

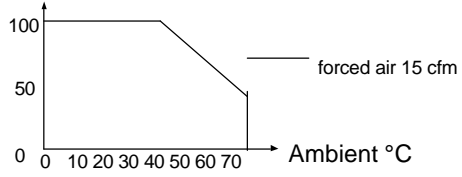

### 3.2.3 Connector Pin Assignments

#### The Type of Connector

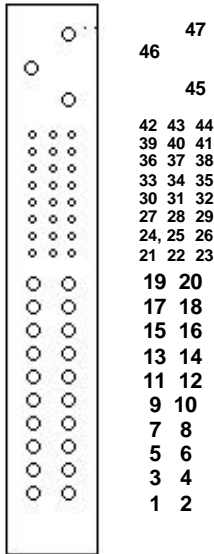

Positronic Industries  
 Part Number:  
 PCI47M400A1  
 or PCIH47M400A1.  
 View from mating face

#### Pin Signals

Pin#	Signal Name	Pin#	Signal Name
1-4	V1	32	V2 ADJ
5-12	RTN	33	V2 SENSE
13-18	V2	34	S RTN
19	RTN	35	V1 SHARE
20	V3	36	X
21	V4	37	X
22	RTN	38	DEG#
23	X	39	INH#
24	RTN	40	X
25	GA0	41	V2 SHARE
26	X	42	FAL#
27	EN#	43	X
28	GA1	44	X
29	V1ADJ	45	CGND
30	V1 SENSE	46	ACN/+DC IN
31	GA2	47	ACL/-DC IN

## Definitions of Pin Signals

Signal	Definition															
<b>EN#</b>	<b>Enable</b> signal should be used to "turn on" the power supply outputs. EN# is used in conjunction with INH# (see Table 2.1) and is typically connected to ground to enable the power supply after other signals on longer pins have made contact.															
<b>INH#</b>	<b>Inhibit</b> signal should be used to "turn off" the power supply outputs. This signal is on a longer pin than the EN# ( enable ) signal and therefore has precedence over the EN# signal when determining power supply operation. The INH# signal is typically connected to an "ON/OFF" switch. Table 2.1 Module Power Supply Operation <table border="1" data-bbox="362 432 908 515"> <tr> <td><b>INH# =</b></td> <td>Low</td> <td>Low</td> <td>Open</td> <td>Open</td> </tr> <tr> <td><b>EN# =</b></td> <td>Low</td> <td>Open</td> <td>Low</td> <td>Open</td> </tr> <tr> <td><b>Power Status</b></td> <td>"OFF"</td> <td>"OFF"</td> <td>"ON"</td> <td>"OFF"</td> </tr> </table>	<b>INH# =</b>	Low	Low	Open	Open	<b>EN# =</b>	Low	Open	Low	Open	<b>Power Status</b>	"OFF"	"OFF"	"ON"	"OFF"
<b>INH# =</b>	Low	Low	Open	Open												
<b>EN# =</b>	Low	Open	Low	Open												
<b>Power Status</b>	"OFF"	"OFF"	"ON"	"OFF"												
<b>V1 SHARE</b>	<b>V1(+5V) Current Share</b> signal may be used between multiple power supplies for load balancing. This signal is not required for single power supply systems.															
<b>V2 SHARE</b>	<b>V1(+3.3V) Current Share</b> signal may be used between multiple power supplies for load balancing. This signal is not required for single power supply systems.															
<b>SENSE RTN</b>	<b>Return Sense</b> shall be connected to the center of the backplane's ground plane for accommodating power distribution losses. This signal is required for modular power supplies.															
<b>V1</b>	<b>V1( +5V )</b> shall be connected via a low impedance to the backplane's power plane for minimizing power distribution losses. This signal is required for all modular power supplies.															
<b>V2</b>	<b>V1( +3.3V )</b> shall be connected via a low impedance to the backplane's power plane for minimizing power distribution losses. This signal is required for all modular power supplies.															
<b>V3</b>	<b>V1( +12V )</b> shall be connected via a low impedance to the backplane's power plane for minimizing power distribution losses. This signal is required for all modular power supplies.															
<b>V4</b>	<b>V1( -12V )</b> shall be connected via a low impedance to the backplane's power plane for minimizing power distribution losses. This signal is required for all modular power supplies.															
<b>RTN</b>	<b>Return</b> shall be connected via a low impedance to the backplane's ground plane for minimizing power distribution losses. This signal is required for modular power supplies.															
<b>V1SENSE</b>	<b>V1( +5V )</b> Sense shall be connected to the center of the backplane's power plane for accommodating power distribution losses. This signal is required for all modular power supplies.															
<b>V2SENSE</b>	<b>V1( +3.3V )</b> Sense shall be connected to the center of the backplane's power plane for accommodating power distribution losses. This signal is required for all modular power supplies.															
<b>ACL/ -DC IN</b>	<b>AC Line/Negative DC</b> input shall be used as the AC Line voltage input for supplies operating from AC, or the -DC voltage input for DC input power supplies.															
<b>ACL/ +DC IN</b>	<b>AC Neutral/Positive DC</b> input shall be used as the AC Neutral voltage input for supplies operating from AC, or the +DC voltage															



	input for DC input power supplies. Front panel keying is provided to prevent damaging an AC power supply inserted into a backplane wired for DC and vice versa.
<b>CGND</b>	<b>Chassis GND</b> signal shall be connected to safety ground with a low impedance connection.
<b>V1ADJ</b>	V1 output voltage may be margined up to +10% if V1ADJ input is pulled to RTN or -10% if pulled to V1 using a programming resistor network. Typically usage is $R_t=10KO$ . See Figure 2.1. An open circuit on the backplane shall result in a nominal output voltage.
<b>V2ADJ</b>	V2 output voltage may be margined up to +10% if V2ADJ input is pulled to RTN or -10% if pulled to V2 using a programming resistor network. Typically usage is $R_t=10KO$ . See Figure 2.1. An open circuit on the backplane shall result in a nominal output voltage.
<b>DEG#</b>	<b>Derating</b> signal <b>MAY</b> be used as an output from the power supply to indicate that the supply is beginning to derate its power output. This signal is active low. It is an open collector, and should be pulled high by a 10KO resistor. Note that backplanes providing a power supply connector shall connect DEG# to the backplane signal DEG# in the event that a power supply implementing this signal is installed.
<b>FAL#</b>	<b>Supply Fail</b> signal <b>MAY</b> be used as an output from the power supply to indicate that it has failed. This signal is active low. It is an open collector, and should be pulled high by a 10KO resistor. Note that backplanes providing a power supply connector shall connect FAL# to the backplane signal FAL# in the event that a power supply implementing this signal is installed.
<b>GA[2..0]</b>	The physical slot address (GA[2..0]) shall be encoded on the backplane by grounding and leaving unconnected different combinations of pins at each connector. Physical slot addresses are defined by the physical slot number on the platform per Table 3-2-1. Due to the limited number of power supply geographic addresses available, physical slot numbers for power supplies are independent of physical slot numbers for CompactPCI boards. Power supply physical slot numbers shall start at 0 in the top-left corner of the card cage. Each signal shall be pulled up with a $10.KO \pm 10\%$ resistor on any power supply using the geographic addressing signals GA[2..0].

---

**⚡ Caution:**

1. Improperly connected 5S+, 5S-, 3S+, and 3S- leads may damage the power supply.
  2. Because implementation and timing for V1 SHARE, V2 SHARE may vary from manufacturer to manufacturer, interoperability between two or more power supplies from different manufacturers is not guaranteed.
-

---

## 3.3 APS-925AX: 280 ATX Power Supply

### 3.3.1 Introductions

The APS-925AX switching power supply is ideal for use in ATX computers, workstations or equivalent systems. This power supply can be installed with the cPCI-PSF as a 3U CompactPCI power supply module.

### 3.3.2 Specifications

#### ◆ AC Input Characteristics

AC Input voltage is switching automatically according to AC input voltage. The acceptable input voltage range is as following table.

Voltage	Frequency	Minimum	Maximum	Input Current
115 VAC	47 ~ 63Hz	90 VAC	130 VAC	8.0A (300W)
230 VAC	47 ~ 63Hz	180 VAC	260 VAC	4.0A (300W)

#### ◆ DC Output Characteristics

300W	Voltage	+5V	+3.3V	+12V	-5V	-12V	5VSB
	Max. Load	30A	15A	15A	1.0A	1.0A	1.2A
	Rated Load	25A	8A	10A	0.5A	0.5A	0.72A
	Min. Load	2A	0	0.1A	0	0	0
	Max.Power	Combined 150W		120W	2.5W	6W	4W

At factory, all outputs in 60% rated load condition , the +5V output is set to between 4.80V and 5.20V. The other outputs are checked to be within the specified voltage accuracy range.

#### ◆ Output power

The total DC continuous power shall be kept within 280W at ambient temperature of 40°C below, and input voltage at 115VDC or 230VAC. The maximum combined output power on the 3V3 and 5V rails is 150W. The maximum outputs load is not allowed for more then 30 seconds.

#### ◆ Ripple & Noise

The peak to peak ripple and noise for +5V, +3.3V output are less than 50mV, and for the other output are less than 100mV at rated load. Measuring is done by 15MHz bandwidth limited oscilloscope and terminated each output with a 0.47  $\mu$ F capacitor.



### Line regulation

The output line regulation for each output is less than  $\pm 1\%$  while measuring at rated load and  $\pm 10\%$  of 115VAC or 230VAC input voltage changing.

### ◆ Load regulation

The output voltage load regulation is less than the values in the following table by changing each output load  $\pm 40\%$  from 60% rated load, and keep all other outputs at 60% rated load.

Voltage	+5V	+3.3V	+12V	-5V	-12V	5VSB
Regulation	$\pm 3\%$	$\pm 2\%$	$\pm 5\%$	$\pm 2\%$	$\pm 2\%$	$\pm 3\%$

### ◆ Efficiency: The efficiency is higher than 65% while measuring at nominal line and rated output.

### ◆ Hold up time

The hold up time is longer than 20ms at 115 VAC input and rated load, which is measured from the end of the last charging pulse , to when the main output drops down to 95% output voltage.

### ◆ Over voltage protection

For some reason the power supply might fail to control itself , the build-in crowbar circuit will automatically shut down the outputs to avoid damaging the external circuits . The trip point of O.V.P. circuit is around 5.7V to 7.0V.

### ◆ Short circuit protection

The power supply will go into hiccup mode function against short circuit or over load conditions. If the faults condition removed, the power supply will restart automatically.

### ◆ Power good signal

The power is turned on, the power good signal will go high between 100ms to 500ms after all output DC voltage are within regulation limits.

### ◆ Power fail signal

The power fail signal will go low at least 1ms before any of the output voltages fall below the regulation limits.

### ◆ Power ON signal

This TTL compatible signal (active low) is use to switch ON the main output . When Power on is disconnected from secondary common , all outputs except +5Vsb shall turn off .

### ◆ Environment Specifications

- Operating temperature: 0°C to 70°C  
When the ambient temperature is over 40°C (115V/230V) , the output power should be de-rated as following curve:

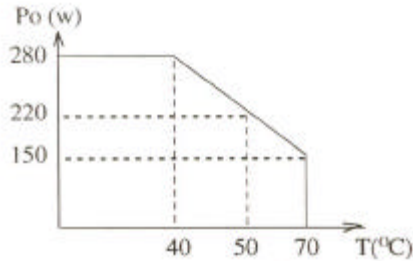

- Storage temperature: -40°C to +75°C
- Operating humidity: The power supply can operate from 5% humidity to 95% humidity non-condensing at 40°C
- ◆ Regulatory Agency Certification
  - Safety standards: Designed to meet the following standards:  
UL 1950  
CSA 22.2 NO.234  
EN 60950
  - EMI standards: Designed to meet the following radiated limits:  
FCC class "B"  
EN55022 class "B"
  - EMS standards: Designed to meet the following standards:  
IEC-801-2 8KV air discharge  
IEC-801-3 3V/M  
IEC-801-4 2KV  
IEC-801-5 2KV

◆ ATX Power Connector definition

Signal	Pin No.	Pin No.	Signal
+3.3V	1	11	+3.3V
+3.3V	2	12	-12V
GND	3	13	GND
+5V	4	14	PS_ON
GND	5	15	GND
+5V	6	16	GND
GND	7	17	GND
PWR_OK	8*	18	-5V
+5V SB	9*	19	+5V Sense
+12V	10	20	+5V

# 4

## 3U Backplane

In this chapter, specifications of many 3U backplane options will be included:

- cBP-3400 series: 64-bit 3U CompactPCI backplane
- cBP-3100 series: 32-bit 3U CompactPCI backplane with optional DIN socket
- cBP-3200 series: 32-bit 3U CompactPCI backplane with rear I/O option

Please refer the each section for detail product list of every series. The following backplane for installing CompactPCI redundant power supply unit are also described:

- cBP-3052E: Redundant power supply backplane for two 31-pin PSUs
- cBP-3051: Power supply backplane for one 31-pin plug-in PSU
- cBP-3062: Redundant power supply backplane for two 47-pin PSUs

---

## 4.1 cBP-3400 Series

### 4.1.1 Features

- ◆ CompactPCI PICMG 2.0 R2.1 compliant
- ◆ Support 3U, 64-bit CompactPCI bus on P1 and P2, support 7-bus mastering I/O slots
- ◆ Number of slots: 8/6/4 slots (include systems slots)
- ◆ 10 layers PCB for accurate impedance control
- ◆ Optional DIN plug-in socket for plug-in power supply
- ◆ Support ATX, PS2 and screw terminals for DC power input connector

### 4.1.2 Products List

- cBP-3408: 8-slot, 3U 64-bit CompactPCI backplane
- cBP-3406: 6-slot, 3U 64-bit CompactPCI backplane
- cBP-3404: 4-slot, 3U 64-bit CompactPCI backplane
- cBP-3408P: 8-slot, 3U 64-bit CompactPCI backplane with DIN socket for PSU
- cBP-3406P: 6-slot, 3U 64-bit CompactPCI backplane with DIN socket for PSU
- cBP-3404P: 4-slot, 3U 64-bit CompactPCI backplane with DIN socket for PSU

### 4.1.3 PCB Drawing

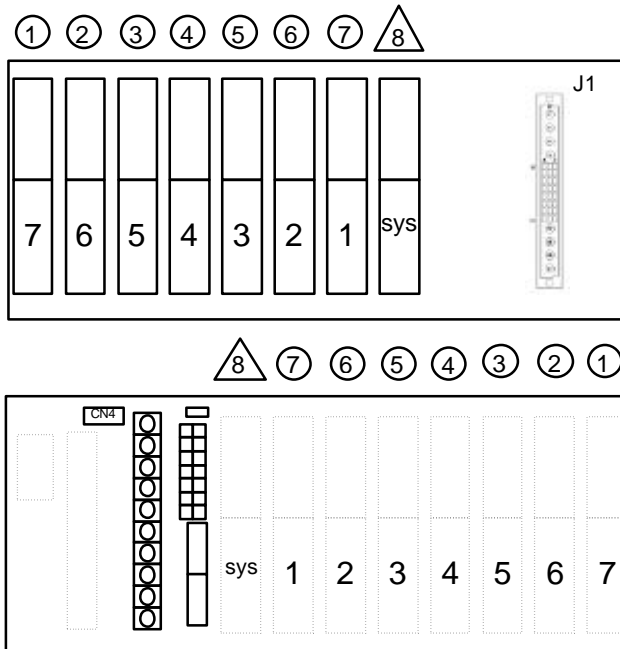

### 4.1.4 Specifications

- ◆ Compliant to CompactPCI PICMG 2.0 R2.1 specifications
- ◆ Standard 3U form factor
- ◆ Four power input connectors: ATX, PS2, screw terminal, plug-in PSU input connectors
- ◆ V(I/O) selectable from +5V or +3.3V.(default +5V)
- ◆ Dimension: 133.35 mm x 243.8 mm x 3.2 mm (3U height, 12-slot width)











### 4.1.5 Connectors pin assignments

- ◆ P1 & P2 of system slot: Standard 64-bit CompactPCI specifications of the PICMG 2.0 R2.1 specifications
- ◆ P1 & P2 of I/O slot: Standard 64-bit CompactPCI specifications of the PICMG 2.0 R2.1 specifications

- ◆ CN1: Standard ATX DC Power input connector

Signal	Pin No.	Pin No.	Signal
+3.3V	1	11	+3.3V
+3.3V	2	12	-12V
GND	3	13	GND
+5V	4	14	PS_ON
GND	5	15	GND
+5V	6	16	GND
GND	7	17	GND
PWR_OK	8*	18	-5V
+5V SB	9*	19	+5V Sense
+12V	10	20	+5V

- ◆ CN2: Standard PS2 DC Power input connector
- ◆ CN3: General Purpose screw terminals

CN3	Pin #	Name
	1	FAL#
	2	DEG#
	3	-12V
	4	+12V
	5	GND
	6	+5V
	7	V(I/O)
	8	+3.3V
	9	GND
	10	+5V

- ◆ J1: Compliant the 31-pin CompactPCI power supply interface standard of the PICMG 2.11. **(Note: This connector is only available on the -P version)**
- ◆ CN5: AC Input terminals for the plug-in power supply unit on J1. **(Note: This connector is only available on the -P version)**
- ◆ JP1: DC power inhibit signal, it is for inhibit the ATX PSU. This connector is used for power-on switch which connect to the pin #14 of CN3. When the system is using PS2 power supply, the pin 1 and pin 2 must be shorted.

JP1	Pin #	Name
	1	PS_ON
	2	GND

- ◆ CN4: Power Managing Signals, the signals are from the CompactPCI power connector J1. The pin definitions are as following.



<b>Signal</b>	<b>Pin No.</b>	<b>Pin No.</b>	<b>Signal</b>
GND	1	2	+5V
GND	3	4	DEG#
GND	5	6	FAL#
GND	7	8	INH#
GND	9	10	PRST#
GND	11	12	+5V
GND	13	14	+12V

Please note that to short the pin #7 and pin #8 can disable the DC power output from CN2 CompactPCI power interface.

## 4.2 cBP-3100 Series

The cBP-3100 series products are with the same PCBs as the cBP-3400 series products. The only difference is that the P2 of the I/O slots are removed for cost reduction. All the other features are exactly the same as the cBP-3400 series products.

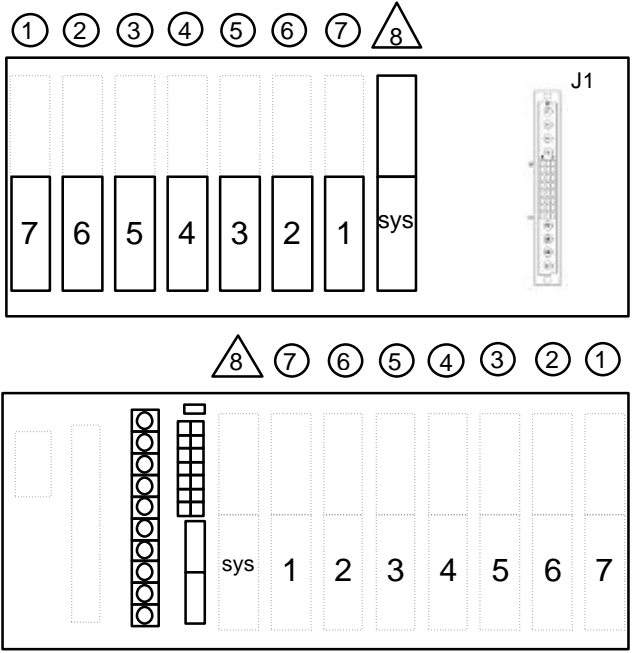

---

## 4.3 cBP-3200 Series

### 4.3.1 Features

- ◆ Compliant to CompactPCI PICMG 2.0 R2.1 specifications
- ◆ Support standard 3U form factor
- ◆ 32-bit CompactPCI bus on P1, support 7-bus mastering I/O slots
- ◆ Optional P2 with rear I/O capability
- ◆ Support ATX and screw terminals for DC power input connectors
- ◆ V(I/O) selectable from +5V or +3.3V.
- ◆ 10 layers PCB for accurate impedance control
- ◆ Dimension: 133.35 mm x 182.0 mm x 3.2 mm (3U height, 9-slot width)

### 4.3.2 Products List

- cBP-3208: 8-slot, 3U 64-bit CompactPCI backplane
- cBP-3206: 6-slot, 3U 64-bit CompactPCI backplane
- cBP-3204: 4-slot, 3U 64-bit CompactPCI backplane
- cBP-3208R: 8-slot, 3U 64-bit CompactPCI backplane with rear I/O
- cBP-3206R: 6-slot, 3U 64-bit CompactPCI backplane with rear I/O
- cBP-3204R: 4-slot, 3U 64-bit CompactPCI backplane with rear I/O

### 4.3.3 PCB Drawing

*cBP-3208:*

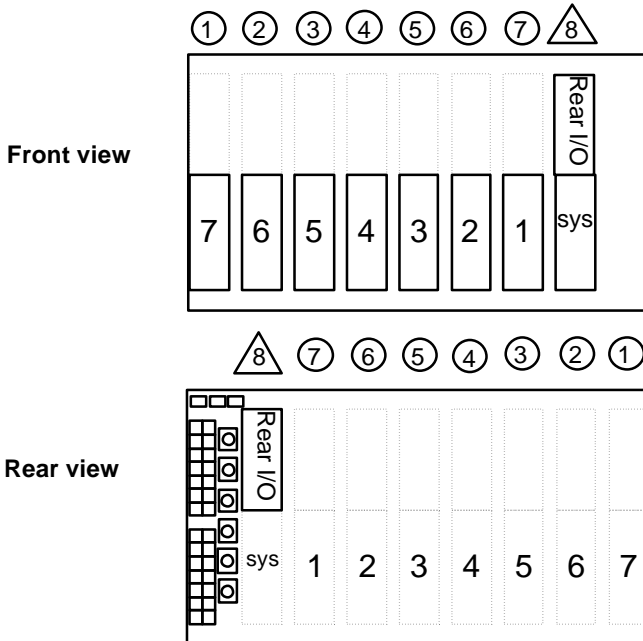

**cBP-3208R:with P2 rear I/O**

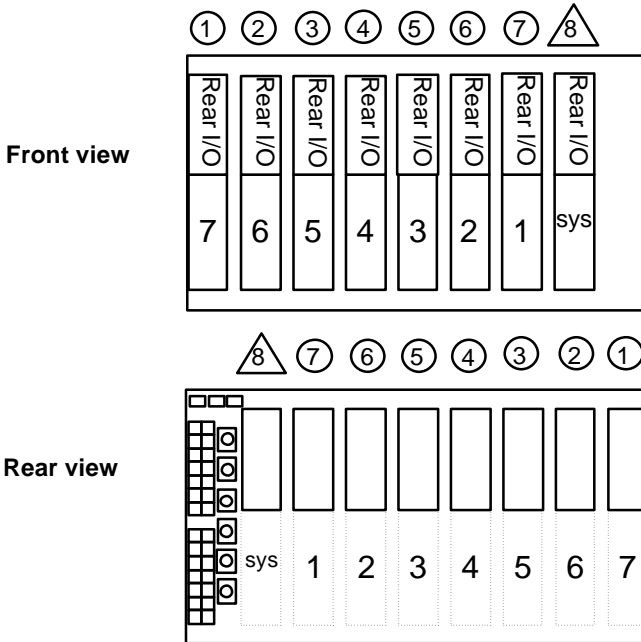







**4.3.4 Connectors pin assignments**

- ◆ P1 & P2 of system slot: Standard 32-bit CompactPCI specifications of the PICMG 2.0 R2.1 specifications
- ◆ P1 of I/O slot: Standard 32-bit CompactPCI specifications of the PICMG 2.0 R2.1 specifications
- ◆ P2 of I/O slot: reserved for rear I/O applications. The P2 connectors are installed only on the cPCI-3208R, 3206R and 3204R versions
- ◆ CN1 and CN2: ATX-like DC Power input connectors

Signal	Pin No.	Pin No.	Signal
+3.3V	1	11	+3.3V
+3.3V	2	12	-12V
GND	3	13	GND
+5V	4	14	INH#
GND	5	15	GND
+5V	6	16	+5V Sense-
GND	7	17	GND
FAL#	8*	18*	JP7
DEG#	9*	19	+5V Sense+
+12V	10	20	+5V

◆ General Purpose screw terminals

	Position (from top to bottom)	Name
	1	+3.3V
	2	V(I/O)
	3	+5V
	4	GND
	5	+12V
	6	-12V

**Note:** that the V(I/O) must be shorted to either +3.3V or +5V. The default factory setting is to shorted at +5V.

◆ JP8 INH#: DC power inhibit signal

It is for inhibiting the ATX power supply. This connector is used for power-on switch.

JP8	Pin #	Name
	1	INH#
	2	GND

◆ JP9 RST#: System reset signal

JP9	Pin #	Name
	1	RST#
	2	GND

◆ JP10 FAL#: Power supply fail input

JP10	Pin #	Name
	1	FAL#
	2	GND

◆ JP7 +12V Sense: +12V Sense Jumper

JP7	Pin #	Name
	1	From pin #18 of CN1/CN2
	2	Connect to +12V Sense

When the normal ATX power supply is used, the pin #18 of CN1/CN2 is with -5V power, please let this jumper open.

When 31-pin CompactPCI power supply is used, this pin is not used and this jumper should be left open.

When 47-pin CompactPCI power supply is used, the +12V sense is usable, therefore, the jumper can be shorted to provide this signal.

---

## 4.4 cBP-3052E Backplane

### 4.4.1 Specifications

- ◆ Compliant with 31-pin CompactPCI power standard of PICMG 2.11
- ◆ Support two 3U redundant power supply unit
- ◆ With external AC power input screw terminal
- ◆ With two ATX DC output connectors
- ◆ Dimension: 133.35 mm x 81.0 mm x 3.2 mm (3U height, 4-slot width)

### 4.4.2 PCB Drawing

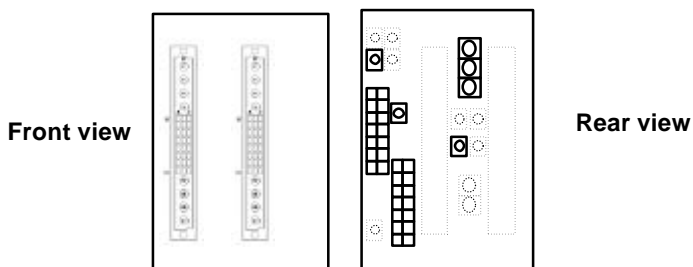

### 4.4.4 Connectors pin assignments

- ◆ J1 & J2: Standard 31-pin CompactPCI power supply sockets, compliant with PICMG 2.11 specifications
- ◆ CN1, CN2: Two identical ATX-like power output connectors

Signal	Pin No.	Pin No.	Signal
+3.3V	1	11	+3.3V
+3.3V	2	12	-12V
GND	3	13	GND
+5V	4	14	INH#
GND	5	15	GND
+5V	6	16	5V Sense-
GND	7	17	GND
FAL#	8	18	N/C
DEG#	9	19	+5V Sense+
+12V	10	20	+5V



---

**Note:** Pin #8, #9, and #18 are not standard ATX power definition.

---

- ◆ CN5: Screw terminals for external AC input power lines
- ◆ CN7: Screw terminals for GND (CN8, CN9, CN10 are not installed.)
- ◆ CN13: Screw terminals for +5V (CN14 is not installed)
- ◆ CN15: Screw terminal for +12V
- ◆ CN16: Screw terminal for -12V is not installed.
- ◆ CN11, CN12: Screw terminals for +3.3V are not installed

---

## 4.5 cBP-3051

### 4.5.1 Specifications

- ◆ Compliant with 31-pin CompactPCI power standard of PICMG 2.11
- ◆ Support one 3U plug-in power supply unit
- ◆ With external AC power input screw terminal
- ◆ With one ATX DC output connectors

### 4.5.2 PCB Drawing

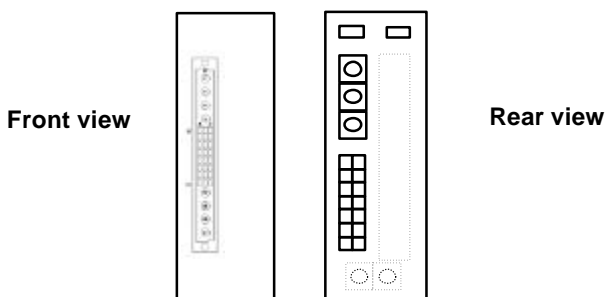

### 4.5.3 Connectors pin assignments

- ◆ J1: Standard 31-pin CompactPCI power supply sockets, compliant with PICMG 2.11 specifications
- ◆ CN1: ATX-like power output connector

Signal	Pin No.	Pin No.	Signal
+3.3V	1	11	+3.3V
+3.3V	2	12	-12V
GND	3	13	GND
+5V	4	14	INH#
GND	5	15	GND
+5V	6	16	5V Sense-
GND	7	17	GND
FAL#	8*	18*	N/C
DEG#	9*	19	+5V Sense+
+12V	10	20	+5V

---

**Note :** Pin #8, #9, and #18 are not standard ATX power definition.

---

- ◆ CN5: AC power lines (include AC LINE, AC NEUTRAL, Chassis GND)

- ◆ J4 INH#: DC power inhibit signal

It is for inhibiting the ATX DC power supply output. This connector can be used for power-on switch.

	Pin #	Name
	1	INH#
	2	GND

- ◆ J3 ISH: +5V current sharing signal, this connector is used only when more than two cBP-3051 backplanes are used in one system.

	Pin #	Name
	1	ISH
	2	GND

---

## 4.6 cBP-3062 Backplane

### 4.6.1 Specifications

- ◆ Compliant with 47-pin CompactPCI power standard of PICMG 2.11
- ◆ Support two 3U redundant power supply unit
- ◆ With external AC power input screw terminal
- ◆ With two ATX DC output connectors
- ◆ Dimension: 133.35 mm x 81.0 mm x 3.2 mm (3U height, 4-slot width)

### 4.6.2 PCB Drawing

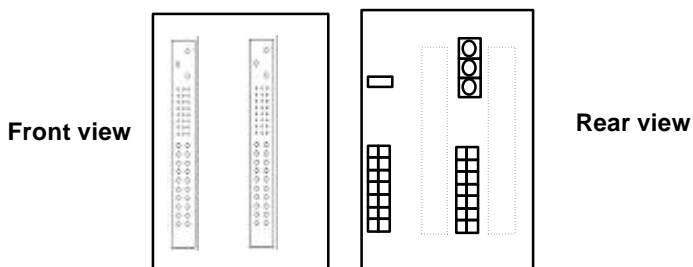

### 4.6.3 Connectors pin assignments

- ◆ CN101 & CN102: Standard 47-pin CompactPCI power supply sockets, compliant with PICMG 2.11 specifications
- ◆ CN103: ATX-like power output connectors

Signal	Pin No.	Pin No.	Signal
V2SENSE	1	11	V2
V2	2	12	V4
GND	3	13	GND
V1	4	14	INH#
GND	5	15	GND
V1	6	16	SRTN
GND	7	17	GND
FAL#1	8*	18*	V3SENSE
DEG#1	9*	19	V1SENSE
V3	10	20	V1

---

**Note :** 1. Pin #8, #9, and #18 are not standard ATX power definition.  
2. V1=+5V; V2= 3.3V; V3 = +12V; V4=-12V

---

- ◆ CN104 extended connector for power sharing

Signal	Pin No.	Pin No.	Signal
V2SENSE	1	11	V2
V2	2	12	V4
GND	3	13	GND
V1	4	14	INH#
GND	5	15	GND
V1	6	16	SRTN
GND	7	17	GND
FAL#2	8*	18*	V3SENSE
DEG#2	9*	19	V1SENSE
V3	10	20	V1

---

**Note:** 1. Pin #8, #9, and #18 are not standard ATX power definition.  
 2. V1=+5V; V2= 3.3V; V3 = +12V; V4=-12V

---

- ◆ CN105 INH#: DC power output inhibit signal. It is for inhibiting the DC power supply. This connector can be used for power-on switch.

CN105	Pin #	Name
	1	INH#
	2	GND

- ◆ CN107: Screw terminals for external AC input power lines
- ◆ CN106: Current sharing connector, this connector is used only when multiple power backplane is used in the same time.

Signal	Pin No.	Pin No.	Signal
V1SENSE	1	2	V3SENSE
GND	3	4	V2SENSE
GA2#2	5	6	GA2#1
GA1#2	7	8	GA1#1
GA0#2	9	10	GA0#1
N/C	11	12	N/C

# 5

## LCD Kit

---

### 5.1 Features

- ◆ High Brightness 6.4 inches TFT LCD
- ◆ Modular design for easy mounting on any 3U CompactPCI Chassis
- ◆ Integrated with back light inverter
- ◆ Two back-light lamps with 15000 hours long life time
- ◆ Optional touch screen with internal RS-232 interface

---

### 5.2 Mechanical Drawing

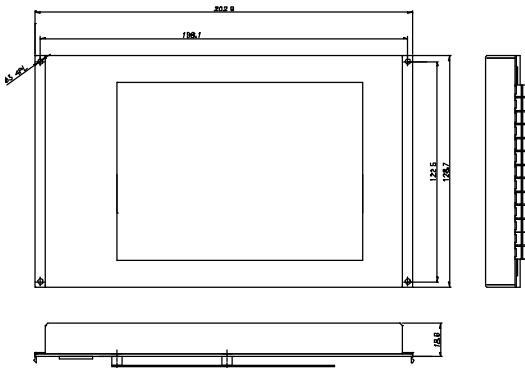

---

## 5.3 Specifications

- ◆ Dimension: 3U height x 10-slot (40HP) width
- ◆ Screen Size: 6.4 inches (diagonal)
- ◆ Resolution: 640 x 480 x 18-bit colors (262,144 colors)
- ◆ Pixel pitch: 0.203 mm x 0.203 mm
- ◆ High brightness 300 cd/m<sup>2</sup>
- ◆ Lamp life time: 15,000 hours @ 25°C
- ◆ Integrated with back light inverter
- ◆ Power requirement:
  - 5V @ 6.0 W (for LCD panel)
  - +12V @ 300 mA x 2 (for two backlight inverters)

## 5.4 Connectors Pin Assignment

### LCD Signal Connector on the LCD

Pin #	Symbol	Function	Pin #	Symbol	Function
1	GND	Ground	17	G4	Green Data Signal
2	CLK	Clock signal for sampling image digital data	18	G5	Green Data Signal
3	Hsync	Horizontal Sync Signal	19	GND	Ground
4	Vsync	Vertical Sync Signal	20	B0	Blue Data Signal
5	GND	Ground	21	B1	Blue Data Signal
6	R0	Red Data Signal	22	B2	Blue Data Signal
7	R1	Red Data Signal	23	B3	Blue Data Signal
8	R2	Red Data Signal	24	B4	Blue Data Signal
9	R3	Red Data Signal	25	B5	Blue Data Signal
10	R4	Red Data Signal	26	GND	Ground
11	R5	Red Data Signal	27	DENB	Signal to set horizontal display position
12	GND	Ground	28	VCC	DC 5V power supply
13	G0	Green Data Signal	29	VCC	DC 5V power supply
14	G1	Green Data Signal	30	R/L	Horizontal image shift select
15	G2	Green Data Signal	31	U/D	Vertical image shift select
16	G3	Green Data Signal	--		

### LCD Signal Extension Connector for cPCI-8215

Signal	Pin #	Pin #	Signal
+12V	1	2	+12V
GND	3	4	GND
VDD	5	6	VDD
ENVEE	7	8	GND
P0	9	10	P1
P2	11	12	P3
P4	13	14	P5
P6	15	16	P7
P8	17	18	P9
P10	19	20	P11
P12	21	22	P13
P14	23	24	P15
P16	25	26	P17
P18 (N/C)	27	28	P19 (N/C)
P20 (N/C)	29	30	P21 (N/C)
P22 (N/C)	31	32	P23 (N/C)
GND	33	34	GND
CLk	35	36	FLM
M	37	38	LP
GND	39	40	EN BKL
GND	41	42	ENVDD
VDD	43	44	VDD



## LCD Signal Extension Connector for cPCI-8217

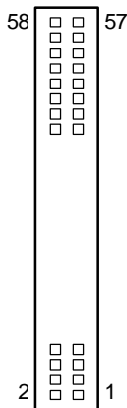

Signal Name	Pin #	Pin #	Signal Name
+12V	1	2	+12V
GND	3	4	GND
+5V	5	6	+5V
ENPVEE	7	8	GND
PD0	9	10	PD1
PD2	11	12	PD3
PD4	13	14	PD5
PD6	15	16	PD7
PD8	17	18	PD9
PD10	19	20	PD11
PD12	21	22	PD13
PD14	23	24	PD15
PD16	25	26	PD17
PD18 (N/C)	27	28	PD19 (N/C)
PD20 (N/C)	29	30	PD21 (N/C)
PD22 (N/C)	31	32	PD23 (N/C)
GND	33	34	GND
SHFCLK	35	36	FLM
M	37	38	LP
GND	39	40	ENABKL
GND	41	42	ENA VDD
VCC	43	44	+5V
NC	45	46	NC
PD24 (N/C)	47	48	PD25 (N/C)
PD26 (N/C)	49	50	PD27 (N/C)
PD28 (N/C)	51	52	PD29 (N/C)
PD30 (N/C)	53	54	PD31 (N/C)
PD32 (N/C)	55	56	PD33 (N/C)
PD34 (N/C)	57	58	PD35 (N/C)

**Note:** Only 44 pins are used. Pin #45 to pin #58 are no used.

### Power and control connector for the backlight inverter

Pin #	Name	Color
1	+12V	Yellow
2	Power On (default connect to +5V)	Red
3	GND	Black
4	VR (default connect to GND)	Black

# 6

## cPCIS-2000 Sub-systems

The following sub-system's configuration will be listed in this chapter.

### ***Sub-systems: (Single System with LCD)***

- cPCIS-2150: 3U CompactPCI Platform with LCD and Off-the-Shelf ATX PSU
- cPCIS-2151: 3U CompactPCI Platform with LCD and Universal AC PSU
- cPCIS-2152: 3U CompactPCI Platform with LCD and Dual Redundant AC PSU

### ***Sub-systems: (Single System without LCD)***

- cPCIS-2100: 3U CompactPCI Platform with Off-the-Shelf ATX PSU
- cPCIS-2102: 3U CompactPCI Platform with Dual Redundant AC PSU

---

## 6.1 cPCIS-2150 Series

- cPCIS-2150 is without rear I/O connectors
- cPCIS-2150R is with rear I/O connectors

### 6.1.1 Features

- Standard 19" 3U CompactPCI form factor, 4U in height
- Attached high brightness 6.4" TFT LCD for user interface display
- Attached Auto-switched off-the-shelf 280W ATX power supply
- Using cBP-3208 backplane with 32-bit CompactPCI bus
- Accept 7 I/O slots and one system slot
- Side handle design for portable instrument
- Two built-in 50 CFM fans for self-cooling system
- Removable fans and air-filter
- Suitable for both rack-mount and desktop applications
- Comprehensive EMC shielding
- cPCIS-2150R is equipped with cBP-3208R and rear I/O card guides for rear I/O applications

### 6.1.2 Configurations

- ◆ Chassis: cPCIS-2000A
- ◆ Backplane:
  - cBP-3208 is for 32-bit CompactPCI bus without rear I/O connectors
  - cBP-3208R is for 32-bit CompactPCI bus with rear I/O connectors
- ◆ Power Supply: 280W ATX power supply is installed with cPCI-PSF
- ◆ LCD module: cPCI-LCD
- ◆ I/O slots configuration:
  - 10-slot is installed with high brightness 6.4" TFT LCD
  - 7-slot for I/O module
  - 3-slot for system module
  - 1-slot spared
  - cPCI-PSF Power supply frame is installed behind the LCD
  - An extra LCD controller card (cPCI-8215 or 8217) should be installed

### 6.1.3 Ordering Options

To complete the system to work, you should order an optional LCD controller card:

- ◆ cPCI-8215: LCD controller card with C&T69000 (embedded 2MB RAM)
- ◆ cPCI-8217: LCD controller card with SMI chipset (embedded 4MB RAM)

The slot-panels with EMC gasket for the front or rear I/O cards are optional and not installed with this sub-system.

- ◆ cPCI-SP3E: 3U slot-panel with EMC gasket for both front I/O or rear I/O

---

## 6.2 cPCIS-2151 Series

### 6.2.1 Features

- Standard 19" 3U CompactPCI form factor, 4U in height
- Attached high brightness 6.4" TFT LCD for user interface display
- Attached 175W Universal AC input power supply
- Using cBP-3108P backplane with 32-bit CompactPCI bus
- Accept 6 I/O slots due to the available front space
- Side handle design for portable instrument
- Two built-in 50 CFM fans for self-cooling system
- Removable fans and air-filter
- Suitable for both rack-mount and desktop applications
- Comprehensive EMC shielding

### 6.2.2 Configurations

- ◆ Chassis: cPCIS-2000A
- ◆ Backplane: cBP-3108P for 32-bit CompactPCI bus
- ◆ Power Supply: Installed 175W power supply cPS-150R
- ◆ LCD module: cPCI-LCD
- ◆ I/O slots configuration:
  - 10-slot is installed with high brightness 6.4" TFT LCD
  - 6-slot for I/O module
  - 3-slot for system module
  - 2-slot is installed with single 175W cPS-150R PSU
  - An extra LCD controller card (cPCI-8215 or 8217) should be installed

### 6.2.3 Ordering Options

To complete the system to work, you should order an optional LCD controller card:

- ◆ cPCI-8215: LCD controller card with C&T69000 (embedded 2MB RAM)
- ◆ cPCI-8217: LCD controller card with SMI chipset (embedded 4MB RAM)

The slot-panels with EMC gasket for the front or rear I/O cards are optional and not installed with this sub-system.

- ◆ cPCI-SP3E: 3U slot-panel with EMC gasket for both front I/O or rear I/O

---

## 6.3 cPCIS-2100 Series

- cPCIS-2100 is without rear I/O connectors
- cPCIS-2100R is with rear I/O connectors

### 6.3.1 Features

- Standard 19" 3U CompactPCI form factor, 4U in height
- Optional auto-switched off-the-shelf 280W ATX power supply
- Using cBP-3208 backplane with 32-bit CompactPCI bus
- Accept 7 I/O slots and one system slot
- Side handle design for portable instrument
- Two built-in 50 CFM fans for self-cooling system
- Removable fans and air-filter
- Suitable for both rack-mount and desktop applications
- Comprehensive EMC shielding
- cPCIS-2100R is equipped with cBP-3208R and rear I/O card guides for rear I/O applications

### 6.3.2 Configurations

- ◆ Chassis: cPCIS-2000A
- ◆ Backplane:
  - cBP-3208 is for 32-bit CompactPCI bus without rear I/O connectors
  - cBP-3208R is for 32-bit CompactPCI bus with rear I/O connectors
- ◆ Power Supply: installed with cPCIS-PSF kit, the power supply is optional.
- ◆ LCD module: cPCI-LCD
- ◆ I/O slots configuration:
  - 7-slot for I/O module
  - 3-slot for system module
  - 2-slot spared
  - 9-slot for cPCI-PSF is installed on the rear panel

### 6.3.3 Ordering Options

To complete the system to work, you should order an optional ATX power supply:

- ◆ APS-925AX: 280W Auto-switched AC input ATX power supply

You can also fit any standard PS2 sized power supply into the slot-panels with EMC gasket for the front or rear I/O cards with optional and not installed with this sub-system.

- ◆ cPCI-SP3E: 3U slot-panel with EMC gasket for both front I/O or rear I/O



---

## 6.4 cPCIS-2102 Series

### 6.4.1 Features

- Standard 19" 3U CompactPCI form factor, 4U in height
- Attached Two cPS-150R for Universal AC redundant power supply
- Using cBP-3208P backplane with 32-bit CompactPCI bus
- Accept 7 I/O slots due to the available front space
- Side handle design for portable instrument
- Two built-in 50 CFM fans for self-cooling system
- Removable fans and air-filter
- Suitable for both rack-mount and desktop applications
- Comprehensive EMC shielding
- cPCIS-2102R is equipped with cBP-3208R and rear I/O card guides for rear I/O applications

### 6.4.2 Configurations

- ◆ Chassis: cPCIS-2000A
- ◆ Backplane:
  - cBP-3208 is for 32-bit CompactPCI bus without rear I/O connectors
  - cBP-3208R is for 32-bit CompactPCI bus with rear I/O connectors
  - cBP-3052 backplane for dual redundant power supply
- ◆ Power Supply: Installed two 175W redundant power supply cPS-150R
- ◆ I/O slots configuration:
  - 7-slot for I/O module
  - 3-slot for system module
  - 4-slot is installed with two 175W cPS-150R PSU
  - 7-slot spared

### 6.4.3 Ordering Options

You may specify to use cPS-175 series power supply with cBP-3061 backplane.

The slot-panels with EMC gasket for the front or rear I/O cards are optional and not installed with this sub-system.

- ◆ cPCI-SP3E: 3U slot-panel with EMC gasket for both front I/O or rear I/O

---

## 6.5 cPCIS-2152 Series

### 6.5.1 Features

- Standard 19" 3U CompactPCI form factor, 4U in height
- Attached high brightness 6.4" TFT LCD for user interface display
- Attached Two cPS-150R for Universal AC redundant power supply
- Using cBP-3206 backplane with 32-bit CompactPCI bus
- Accept 5 I/O slots due to the available front space
- Side handle design for portable instrument
- Two built-in 50 CFM fans for self-cooling system
- Removable fans and air-filter
- Suitable for both rack-mount and desktop applications
- Comprehensive EMC shielding
- cPCIS-2152R is equipped with cBP-3206R and rear I/O card guides for rear I/O applications

### 6.5.2 Configuration

- ◆ Chassis: cPCIS-2000A
- ◆ Backplane:
  - cBP-3206 for 32-bit CompactPCI bus without rear I/O
  - cBP-3206R for 32-bit CompactPCI bus with rear I/O
  - cBP-3052 for redundant power supply
- ◆ Power Supply: Installed two 175W redundant power supply cPS-150R
- ◆ I/O slots configuration:
  - 10-slot is installed with high brightness 6.4" TFT LCD
  - 4-slot for I/O module
  - 3-slot for system module
  - 4-slot is installed with two 175W cPS-150R PSU

### 6.5.3 Ordering Options

To complete the system to work, you should order an optional LCD controller card:

- ◆ cPCI-8215: LCD controller card with C&T69000 (embedded 2MB RAM)

- ◆ cPCI-8217: LCD controller card with SMI chipset (embedded 4MB RAM)

You may specify to use cPS-175 series power supply with cBP-3061 backplane.

The slot-panels with EMC gasket for the front or rear I/O cards are optional and not installed with this sub-system.

- ◆ cPCI-SP3E: 3U slot-panel with EMC gasket for both front I/O or rear I/O

# 7

## cPCIS-1000 Sub-systems

The following sub-system's configuration will be listed in this chapter.

***Sub-systems: (Single System with LCD)***

- cPCIS-1151: 3U CompactPCI Platform with LCD and Universal AC PSU

***Sub-systems: (Single System without LCD)***

- cPCIS-1100: 3U CompactPCI Platform with Off-the-Shelf ATX PSU

***Sub-systems: (Dual System)***

- cPCIS-1250: 3U CompactPCI Platform with Dual System

---

## 7.1 cPCIS-1151

### 7.1.1 Features

- Standard 19" 3U CompactPCI form factor, 3U in height
- Attached high brightness 6.4" TFT LCD for user interface display
- Attached 175W Universal AC input power supply
- Using cBP-3108P backplane with 32-bit CompactPCI bus
- Accept 5 I/O slots due to the available front space
- Comprehensive EMC shielding

### 7.1.2 Configurations

- ◆ Chassis: cPCIS-1000
- ◆ Backplane: cBP-3106P for 32-bit CompactPCI bus
- ◆ Power Supply: Installed 175W power supply cPS-150R
- ◆ LCD module: cPCI-LCD
- ◆ I/O slots configuration:
  - 10-slot is installed with high brightness 6.4" TFT LCD
  - 5-slot for I/O module
  - 3-slot for system module
  - 2-slot is installed with single 175W cPS-150R PSU
  - 1-slot for power switch
  - An extra LCD controller card (cPCI-8215 or 8217) should be installed

### 7.1.3 Ordering Options

To complete the system to work, you should order an optional LCD controller card:

- ◆ cPCI-8215: LCD controller card with C&T69000 and 2MB RAM
- ◆ cPCI-8217: LCD controller card with SMI chipset and 8MB RAM

The slot-panels with EMC gasket for the front or rear I/O cards are optional and not installed with this sub-system.

- ◆ cPCI-SP3E: 3U slot-panel with EMC gasket for both front I/O or rear I/O

---

## 7.2 cPCIS-1100 Series

- cPCIS-1100 is without rear I/O connectors
- cPCIS-1100R is with rear I/O connectors

### 7.2.1 Features

- Standard 19" 3U CompactPCI form factor, 3U in height
- Optional PS2-sized ATX power supply
- Using cBP-3208 backplane with 32-bit CompactPCI bus
- Accept 7 I/O slots and one system slot
- Comprehensive EMC shielding
- cPCIS-1100R is equipped with cBP-3208R and rear I/O card guides for rear I/O applications

### 7.2.2 Configurations

- ◆ Chassis: cPCIS-1000
- ◆ Backplane:
  - cBP-3208 is for 32-bit CompactPCI bus without rear I/O connectors
  - cBP-3208R is for 32-bit CompactPCI bus with rear I/O connectors
- ◆ Power Supply: installed with cPCIS-PSF kit, the power supply is optional
- ◆ LCD module: cPCI-LCD
- ◆ I/O slots configuration:
  - 7-slot for I/O module
  - 3-slot for system module
  - 1-slot spared
  - 1-slot for power switch
  - 9-slot for cPCI-PSF is installed on the rear panel

### 7.2.3 Ordering Options

To complete the system to work, you should order an optional ATX power supply:

- ◆ APS-925AX: 280W Auto-switched AC input ATX power supply

You can also fit any standard PS2 sized power supply into the controller.

The slot-panels with EMC gasket for the front or rear I/O cards are optional and not installed with this sub-system.

- ◆ cPCI-SP3E: 3U slot-panel with EMC gasket for both front I/O or rear I/O



---

## 7.3 cPCIS-1250

### 7.3.1 Features

- Standard 19" 3U CompactPCI form factor, 3U in height
- Dual systems in one system
- Using cBP-3106P backplane with 32-bit CompactPCI bus for both system
- Accept 5 I/O slots on each system
- Comprehensive EMC shielding

### 7.3.2 Configurations

- ◆ Chassis: cPCIS-1000
- ◆ Backplane: Two cBP-3106P backplanes are for 32-bit CompactPCI bus without rear I/O connectors
- ◆ Power Supply: installed with 175W power supply
- ◆ LCD module: cPCI-LCD
- ◆ I/O slots configuration:
  - 1-slot for power switch

#### System #1

- 5-slot for I/O module
- 3-slot for system module
- 2-slot for plug-in power supply

#### System # 2

- 5-slot for I/O module
- 3-slot for system module
- 2-slot for plug-in power supply

### 7.3.3 Ordering Options

The slot-panels with EMC gasket for the front or rear I/O cards are optional and not installed with this sub-system.

- ◆ cPCI-SP3E: 3U slot-panel with EMC gasket for both front I/O or rear I/O

# Product Warranty/Service

Seller warrants that equipment furnished will be free from defects in material and workmanship for a period of one year from the confirmed date of purchase of the original buyer and that upon written notice of any such defect, Seller will, at its option, repair or replace the defective item under the terms of this warranty, subject to the provisions and specific exclusions listed herein.

This warranty shall not apply to equipment that has been previously repaired or altered outside our plant in any way as to, in the judgment of the manufacturer, affect its reliability. Nor will it apply if the equipment has been used in a manner exceeding its specifications or if the serial number has been removed.

Seller does not assume any liability for consequential damages as a result from our product uses, and in any event our liability shall not exceed the original selling price of the equipment.

The equipment warranty shall constitute the sole and exclusive remedy of any Buyer of Seller equipment and the sole and exclusive liability of the Seller, its successors or assigns, in connection with equipment purchased and in lieu of all other warranties expressed implied or statutory, including, but not limited to, any implied warranty of merchant ability or fitness and all other obligations or liabilities of seller, its successors or assigns.

The equipment must be returned postage-prepaid. Package it securely and insure it. You will be charged for parts and labor if you lack proof of date of purchase, or if the warranty period is expired.