

cPCIS-2501
3U *CompactPCI* 6-slot
Cubic Chassis
User's Guide



Recycled Paper

©Copyright 2005 ADLINK Technology Inc.
All Rights Reserved.

Manual Rev. 1.00, March 15, 2005

Part Number: 50-15041-1000

The information in this document is subject to change without prior notice in order to improve reliability, design and function and does not represent a commitment on the part of the manufacturer.

In no event will the manufacturer be liable for direct, indirect, special, incidental, or consequential damages arising out of the use or inability to use the product or documentation, even if advised of the possibility of such damages.

This document contains proprietary information protected by copyright. All rights are reserved. No part of this manual may be reproduced by any mechanical, electronic, or other means in any form without prior written permission of the manufacturer.

Trademarks

Product names mentioned herein are used for identification purposes only and may be trademarks and/or registered trademarks of their respective companies.

Getting Service from ADLINK

Customer Satisfaction is top priority for ADLINK TECHNOLOGY INC. If you need any help or service, please contact us.

ADLINK TECHNOLOGY INC.			
Web Site	http://www.adlinktech.com		
Sales & Service	service@adlinktech.com		
TEL	+886-2-82265877	FAX	+886-2-82265717
Address	9F, No. 166, Jian Yi Road, Chungho City, Taipei, 235 Taiwan		

Please email or FAX your detailed information for prompt, satisfactory, and consistent service.

Detailed Company Information			
Company/Organization			
Contact Person			
E-mail Address			
Address			
Country			
TEL		FAX	
Web Site			
Questions			
Product Model			
Environment	OS: Computer Brand: M/B: CPU: Chipset: BIOS: Video Card: NIC: Other:		
Detail Description			
Suggestions for ADLINK			

Table of Contents

1	Introduction	1
1.1	Product Definition	1
1.2	Features.....	2
1.3	Specifications.....	2
1.4	Mechanical Drawing	3
2	Getting Started	5
2.1	Shipping Contents	5
2.2	CompactPCI Board & PSU Installation.....	5
2.3	Powering Up the System	9
3	Backplane	11
3.1	cBP-3206 Backplane	11
	Specifications	11
	Mechanical Drawing	12
	Pin Assignment.....	13
3.2	cBP-3061 Power Backplane	17
	Specifications	17
	Mechanical Drawing	17
	Pin Assignment.....	18
4	Cooling System	21
4.1	Removing and Replacing the Air Filter	21
4.2	Fan Removal and Replacement.....	23
5	Power Supply Unit	25
5.1	CompactPCI: cPS-H325/AC.....	25
	Features	25
	Specifications	25
	Input Characteristics.....	26
	Output Characteristics.....	26
	Important Safety Instructions	29
	Warranty Policy.....	31

1 Introduction

1.1 Product Definition

The cPCIS-2501 3U CompactPCI 6-slot Cubic Chassis is designed for 3U CompactPCI cards and modules without rear I/O. It is 4U in height, 237 mm deep, and suitable for bench top use or wall mounting. It is ideal for industrial or transport applications where small chassis size and versatility are important. A built in cooling system with removable filter provides maximum cooling efficiency, and the 250W cPCI power supply allows easy maintenance. The cPCIS-2501's ability to handle a wide range of temperatures and excellent shock and vibration characteristics make it suitable for operating in a rigorous environment.

This user's manual provides unpacking, operating, and maintenance information for the cPCI-2501 3U CompactPCI 6-slot Cubic Chassis. The cPCI-2501 chassis is assembled using the following components:

Components:

- Chassis: cPRK-2501
- Power Supply: cPS-H325/AC 3U cPCI
- Backplane: cBP-3206 6-slot 32-bit 3U cPCI
- Power Backplane: cBP-3061



cPCIS-2501 Front View

1.2 Features

- Compact size, 4U high enclosure for 3U CompactPCI cards w/o rear I/O
- Board Space: 1 system slot, 5 peripheral slots, 1 PSU slot
- Side handle design for portable applications
- Stand feet on the bottom for desktop use
- Versatile wall-mount applications with mounting kit
- Standard PICMG 2.11 47-Pin modular power supply
- Built-in cooling system
- Bottom-access removable air filter for easy maintenance

1.3 Specifications

CompactPCI Standards	PICMG 2.0 R3.0
Form Factor	3U CompactPCI card without rear I/O
Enclosure	Coated metal plate outer covering with aluminum framework
Cooling System	Bottom-access removable fans for in-take: 12V DC brush-less, dual ball bearing Two fans with 41.4 CFM/each Rated speed for each fan: 3100 ± 250 RPM Rated power for each fan: 2.5W
Power Supply	Power backplane: cBP-3061 Supports single in-rack 3U cPCI 8HP power module PICMG 2.11 47-pin power interface Available power module: cPS-H325/AC (250W)
Backplane	cBP-3206: 6-slot 32-bit 3U cPCI Backplane
Chassis Partition	5 slots for peripheral cards 3 slots for system module 2 slots for three 3U 8HP cPCI power modules
Dimension	221.4 x 237 x 177 (mm, W x D x H, w/o wall mount kit or stand feet)
Operating temperature	0 to 60°C
Storage temperature	-20 to 80°C
Humidity	5% to 95%, non-condensing
Shock	15G peak-to-peak, 11ms duration, non-operation
Vibration	Non-operation: 1.88Grms, 5-500Hz, each axis
Safety, Certification, EBS	CE

2 • Introduction

1.4 Mechanical Drawing

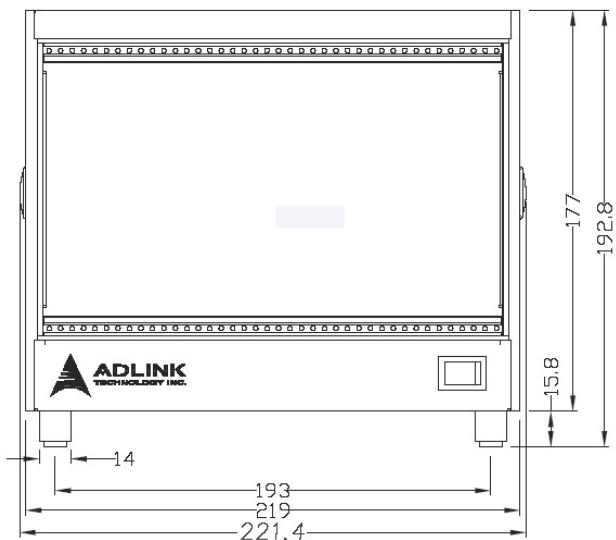

cPCIS-2501 Front View

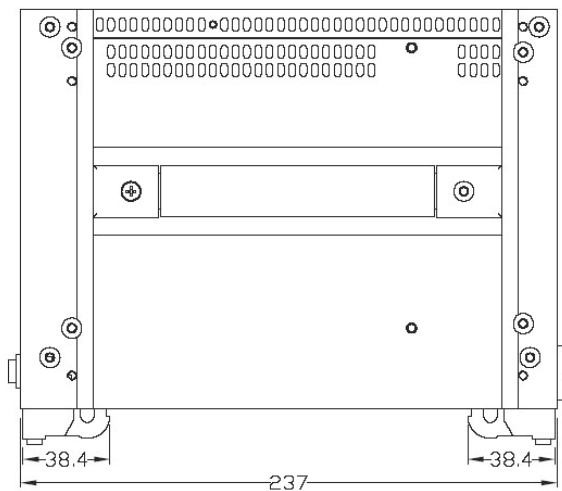

cPCIS-2501 Side View

2 Getting Started

In this chapter, we will describe the unpacking procedure for the cPCIS-2501 and installation procedures for CompactPCI boards and power supply unit (PSU).

2.1 Shipping Contents

Check the shipping carton for any damage. If the shipping carton and contents are damaged, please notify the dealer for a replacement. Retain the shipping carton and packing material for inspection by the dealer. Obtain authorization before returning any product to ADLINK.

Check that the following items are included in the package. If there are any missing items, please contact your dealer:

- One cPCIS-2501 chassis
- cPS-H325/AC power supply
- This user's manual
- Power cord (either N. American or European)

2.2 CompactPCI Board & PSU Installation

CompactPCI connectors are rigid, and therefore require careful handling when inserted and removed. Improper manipulation of the cards will result in damage to the backplane.

System slots usually have obvious indicators (e.g. red card guide rail, triangle mark enclosing the slot number on the backplane, etc.). System cards can only be installed in a system slot. Do not insert a system card into any other slot, or insert any peripheral card into system slot.

The PSU slot also has an obvious indicator such as a green card guide rail in a standard CompactPCI chassis (see photo below).

The handle on CompactPCI cards and PSUs ensures simple and safe installation and removal. Please follow the procedures below to install a CompactPCI module into the cPCIS-2501 chassis:

CompactPCI Card Installation/Removal Procedure

1. Place the chassis on a level surface. Remove the blanking plates where required by undoing the retaining screws at each end. Retain the blanking plates for possible future use. The system should not be put into use without blanking plates for all empty slots, otherwise the EMC and cooling performance will be compromised
2. Hold the SBC module, peripheral card or PSU module vertically. For PSU modules, make sure that the handle is unlatched (i.e. that it is pulled downwards) by first pressing on the locking button with your thumb.
3. Carefully insert the module into the desired slot by sliding the edges of the board into the appropriate card guide rail. Take care to ensure correct alignment of the card with the chassis during insertion to prevent damage to the card and/or backplane.

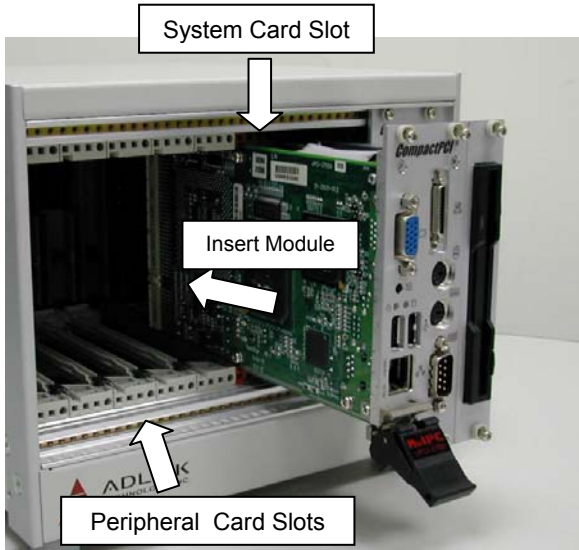

4. Continue inserting the card until the handle engages with the chassis.
5. Pull upwards on the handle for final insertion. For PSU modules, ensure that the locking button on the handle is fully latched into position. Fasten the retaining screws at each end of the card (2 for single slot cards, 4 for double slot cards).

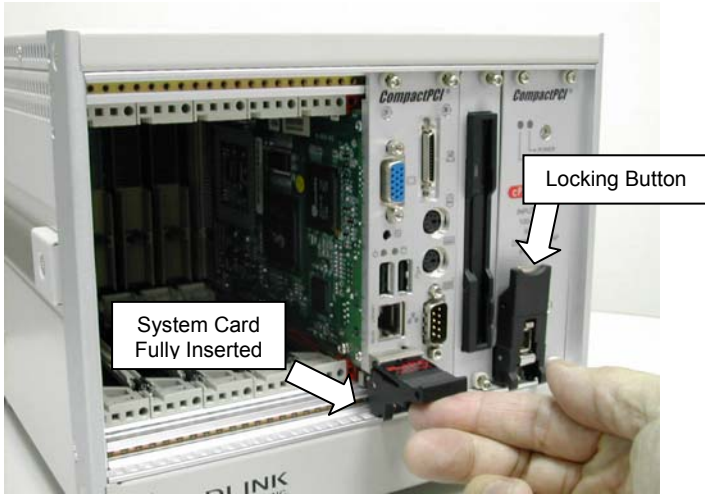

To remove the module, press the locking button (if necessary), and reverse steps 1 through 5 above.

CompactPCI PSU Installation/Removal Procedure

The installation and removal procedures for a CompactPCI PSU are the same as those for CompactPCI boards. See the figures below.

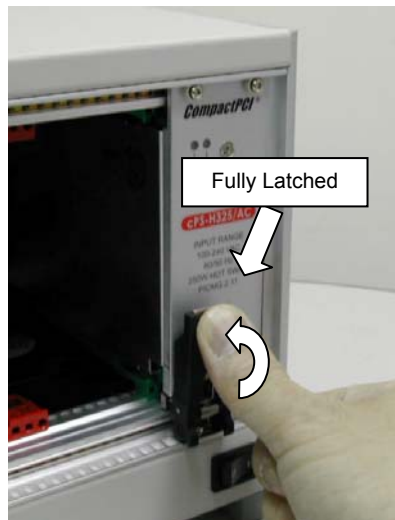
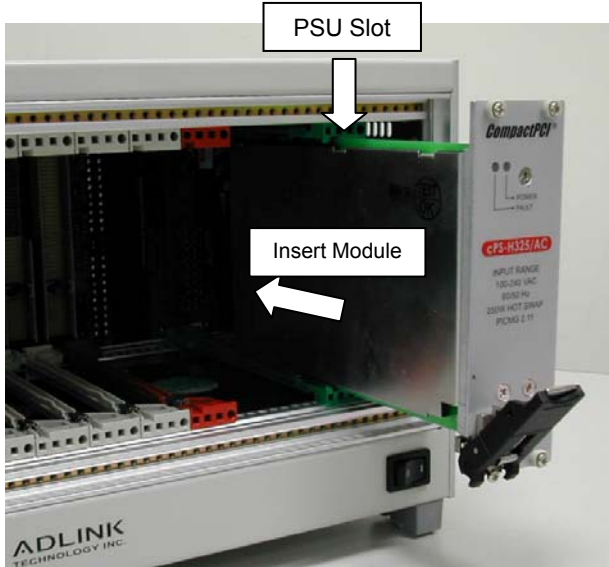

2.3 Powering Up the System

Set the main power switch in the lower right corner of the rear panel to the off position (**O**). Set the secondary power switch in the lower right corner of the front panel to the off position (**I**). Connect the supplied power cord to the socket on the back of the chassis. The supplied PSU is full range 90-240VAC and does not require input voltage setting. Insert a system module and any desired peripheral cards into the appropriate card slots.

To power up the system, set the secondary power switch on the front panel to the on position (**II**).

3 Backplane

In this chapter, we will describe the backplanes for the cPCIS-2501, the cBP-3206 is a 3U CompactPCI 32-bit backplane and the cBP-3061 power backplane.

3.1 cBP-3206 Backplane

Specifications

- Standard CompactPCI height for 3U cPCI cards
- CompactPCI Compliancy
 - PICMG 2.0 CompactPCI core specification R3.0
 - PICMG 2.1 CompactPCI hot swap R2.0
- Dimensions: 100.7 x 128.7 mm
- PCI bus clock: up to 32-bit/33MHz
- System Slot: one R-hand side dual-slot
- Peripheral slots: 5
- Power Connectors: ATX connector x2, DC screw terminals
- V (I/O): 3.3V or 5V selectable, default 5V
- Other connectors: INH#, Reset, PWR_FAL#

Mechanical Drawing

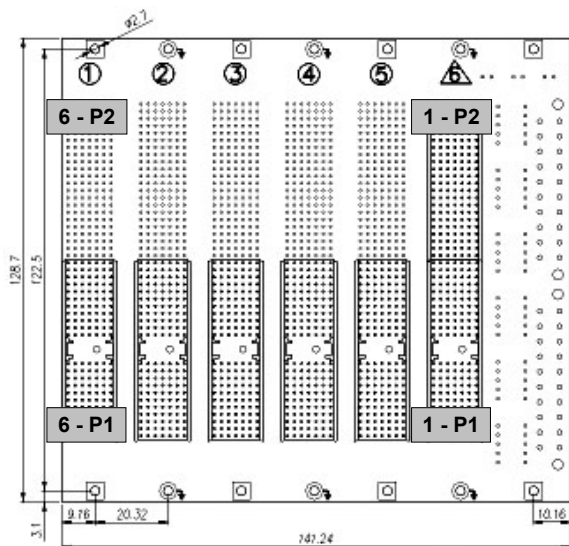

cBP-3206 Front View

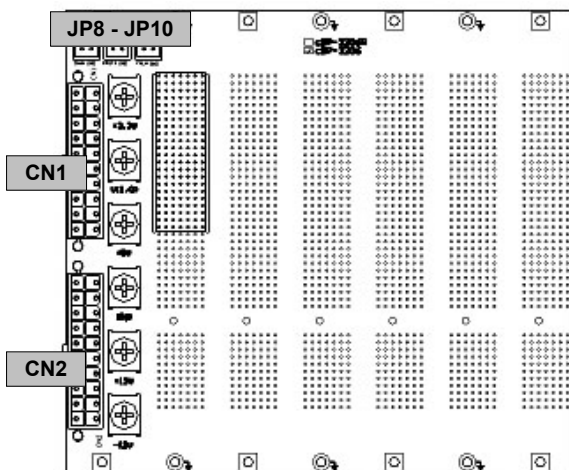

cBP-3206 Rear View

Pin Assignment

➤ [1 – P1] System Slot

Pin	Z	A	B	C	D	E	F
25	GND	+5V	REQ64#	ENUM#	+3.3V	+5V	GND
24	GND	AD[1]	+5V	V(I/O)	AD[0]	ACK64#	GND
23	GND	+3.3V	AD[4]	AD[3]	+5V	AD[2]	GND
22	GND	AD[7]	GND	+3.3V	AD[6]	AD[5]	GND
21	GND	+3.3V	AD[9]	AD[8]	M66EN	C/BE[0]#	GND
20	GND	AD[12]	GND	V(I/O)	AD[11]	AD[10]	GND
19	GND	+3.3V	AD[15]	AD[14]	GND	AD[13]	GND
18	GND	SERR#	GND	+3.3V	PAR	C/BE[1]#	GND
17	GND	+3.3V	IPMB_SCL	IPMB_SDA	GND	PERR#	GND
16	GND	DEVSEL#	GND	V(I/O)	STOP#	LOCK#	GND
15	GND	+3.3V	FRAME#	IRDY#	BDSEL	TRDY#	GND
12-14	Key						
11	GND	AD[18]	AD[17]	AD[16]	GND	C/BE[2]#	GND
10	GND	AD[21]	GND	+3.3V	AD[20]	AD[19]	GND
9	GND	C/BE[3]#	IDSEL	AD[23]	GND	AD[22]	GND
8	GND	AD[26]	GND	V(I/O)	AD[25]	AD[24]	GND
7	GND	AD[30]	AD[29]	AD[28]	GND	AD[27]	GND
6	GND	REQ#	GND	+3.3V	CLK	AD[31]	GND
5	GND	Reserved	Reserved	PCIRST#	GND	GNT#	GND
4	GND	IPMB_PWR	HEALTHY#	V(I/O)	INTP	INTS	GND
3	GND	INTA#	INTB#	INTC#	+5V	INTD#	GND
2	GND	TCK	+5V	TMS	TDO	TDI	GND
1	GND	+5V	-12V	TRST#	+12V	+5V	GND
Pin	Z	A	B	C	D	E	F

➤ [1 – P2] System Slot

Pin	Z	A	B	C	D	E	F
22	GND	GA4	GA3	GA2	GA1	GA0	GND
21	GND	CLK6	GND	NC	NC	NC	GND
20	GND	CLK5	GND	NC	NC	NC	GND
19	GND	GND	GND	NC	NC	NC	GND
18	GND	NC	NC	NC	NC	NC	GND
17	GND	NC	NC	PRST#	REQ6#	GNT6#	GND
16	GND	NC	NC	DEG#	NC	NC	GND
15	GND	NC	NC	FAL#	REQ5#	GNT5#	GND
14	GND	NC	NC	NC	NC	NC	GND
13	GND	NC	NC	NC	NC	NC	GND
12	GND	NC	NC	NC	NC	NC	GND
11	GND	NC	NC	NC	NC	NC	GND
10	GND	NC	NC	NC	NC	NC	GND
9	GND	NC	NC	NC	NC	NC	GND
8	GND	NC	NC	NC	NC	NC	GND
7	GND	NC	NC	NC	NC	NC	GND
6	GND	NC	NC	NC	NC	NC	GND
5	GND	NC	NC	NC	NC	NC	GND
4	GND	V(I/O)	NC	NC	NC	NC	GND
3	GND	CLK4	GND	GNT3#	REQ4#	GNT4#	GND
2	GND	CLK2	CLK3	GND	GNT2#	REQ3#	GND
1	GND	CLK1	GND	REQ1#	GNT1#	REQ2#	GND
Pin	Z	A	B	C	D	E	F

➤ [2 – P1] – [6 – P1] Peripheral Slot

Pin	Z	A	B	C	D	E	F
25	GND	+5V	REQ64#	ENUM#	+3.3V	+5V	GND
24	GND	AD[1]	+5V	V(I/O)	AD[0]	ACK64#	GND
23	GND	+3.3V	AD[4]	AD[3]	+5V	AD[2]	GND
22	GND	AD[7]	GND	+3.3V	AD[6]	AD[5]	GND
21	GND	+3.3V	AD[9]	AD[8]	M66EN	C/BE[0]#	GND
20	GND	AD[12]	GND	V(I/O)	AD[11]	AD[10]	GND
19	GND	+3.3V	AD[15]	AD[14]	GND	AD[13]	GND
18	GND	SERR#	GND	+3.3V	PAR	C/BE[1]#	GND
17	GND	+3.3V	IPMB_SCL	IPMB_SDA	GND	PERR#	GND
16	GND	DEVSEL#	GND	V(I/O)	STOP#	LOCK#	GND
15	GND	+3.3V	FRAME#	IRDY#	GND	TRDY#	GND
12-14	Key						
11	GND	AD[18]	AD[17]	AD[16]	GND	C/BE[2]#	GND
10	GND	AD[21]	GND	+3.3V	AD[20]	AD[19]	GND
9	GND	C/BE[3]#	IDSEL	AD[23]	GND	AD[22]	GND
8	GND	AD[26]	GND	V(I/O)	AD[25]	AD[24]	GND
7	GND	AD[30]	AD[29]	AD[28]	GND	AD[27]	GND
6	GND	REQ#	GND	+3.3V	CLK	AD[31]	GND
5	GND	NC	NC	PCIRST#	GND	GNT#	GND
4	GND	IPMB_PWR	HEALTHY#	V(I/O)	INTP	INTS	GND
3	GND	INTA#	INTB#	INTC#	+5V	INTD#	GND
2	GND	TCK	+5V	TMS	TDO	TDI	GND
1	GND	+5V	-12V	TRST#	+12V	+5V	GND
Pin	Z	A	B	C	D	E	F

➤ [2 – P2] – [6 – P2] Peripheral Slot

Pin	Z	A	B	C	D	E	F
22	GND	GA4	GA3	GA2	GA1	GA0	GND
1-21	GND	NC	NC	NC	NC	NC	GND

➤ CN1 / CN2 – ATX Power Connector

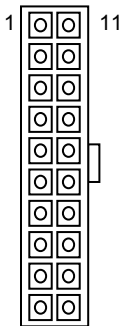

Pin	Signal	Pin	Signal
1	+3.3V	11	+3.3V
2	+3.3V	12	-12V
3	GND	13	GND
4	+5V	14	PS_ON_L
5	GND	15	GND
6	+5V	16	GND
7	GND	17	GND
8	POWER GOOD	18	-5V
9	5V STB	19	+5V
10	+12V	20	+5V

➤ JP8 – connector



Pin #	Signal Name
1	INH#
2	-12V Sense

➤ JP9 – connector



Pin #	Signal Name
1	PRST#
2	GND

➤ JP10 – connector



Pin #	Signal Name
1	FAL#
2	GND

3.2 cBP-3061 Power Backplane

The cBP-3061 is a PICMG 2.11 CompactPCI 3U 47-pin power backplane for one power module. It is used by the cPCIS-2631/2642[R].

Specifications

- CompactPCI Compliancy: PICMG 2.11 CompactPCI Power Interface
- Dimensions: 40.64x 128.7 mm
- Power Module Sockets: one
- AC/DC input screw terminal: yes
- DC output (ATX connector): one
- Cascading voltage Sense: Built-in ATX connector
- INH#/FAL#/DEG# Distribution: Built-in ATX connector

Mechanical Drawing

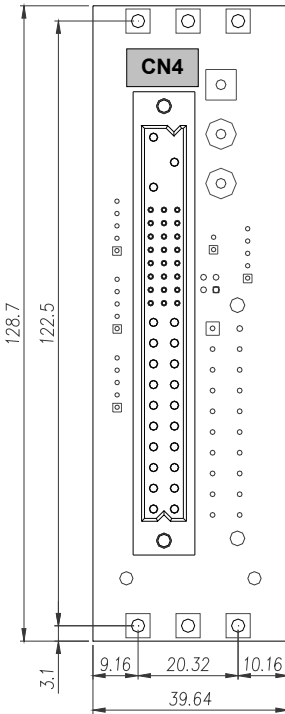

cBP-3061[R] Front View

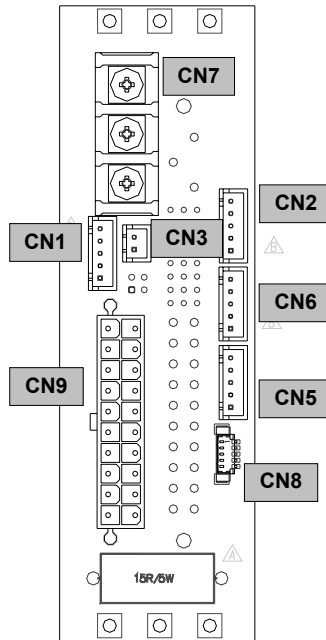

cBP-3061 [R] Rear View

Pin Assignment

- CN1 – Power Sense Connector



Pin #	Signal Name
1	V1_Sense
2	GND_S
3	V2_Sense
4	V3_Sense
5	NC

- CN2 – Power Sense Connector



Pin #	Signal Name
1	V1_Sense
2	GND_S
3	V2_Sense
4	V3_Sense
5	NC

- CN3 – connector



Pin #	Signal Name
1	INHJ
2	GND

➤ CN4 – Modular Power 47P Connector

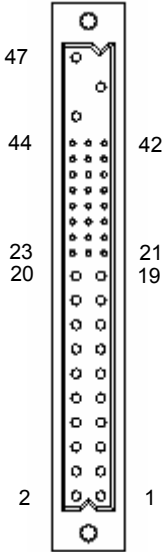

Pin	Signal	Pin	Signal
47	ACL/-DC IN	31	GA2
46	ACN/+DC IN	30	V1 SENSE
45	CGND	29	V1ADJ
44	V3 SHARE	28	GA1
43	IPMB_PWR	27	EN#
42	+FAL#	26	RESERVED
41	V2 SHARE	25	GA0
40	IPMB_SDA	24	RTN
39	INH#	23	RESERVED
38	DEG#	22	RTN
37	IPMB_SCL	21	V4
36	V3 SENSE	20	V3
35	V1 SHARE	19	RTN
34	S RTN	13-18	V2
33	V2 SENSE	5-12	RTN
32	V2ADJ	1-4	V1

➤ CN5 – Current Share Connector



Pin #	Signal Name
1	V1_Share
2	GND
3	V2_Share
4	V3_Share
5	NC

➤ CN6 – Current Share Connector



Pin #	Signal Name
1	V1_Share
2	GND
3	V2_Share
4	V3_Share
5	NC

➤ CN7 –AC/DC in Let Connector



Pin #	Signal Name
1	ACN/DC+
2	ACL/DC-
3	CGND

➤ CN8 – IPMB Connector

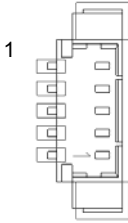

Pin #	Signal Name
1	IPMB_SCL
2	GND
3	IPMB_SDA
4	IPMB_PWR
5	ALERT

➤ CN9 – ATX Power Connector

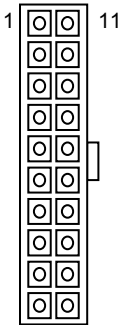

Pin	Signal	Pin	Signal
1	+3.3V	11	+3.3V
2	+3.3V	12	-12V
3	GND	13	GND
4	+5V	14	PS_ON_L
5	GND	15	GND
6	+5V	16	GND
7	GND	17	GND
8	POWER GOOD	18	-5V
9	5V STB	19	+5V
10	+12V	20	+5V

4 Cooling System

The cPCIS-2501 is equipped with two bottom access removable fans for intake to provide an effectively cooled environment. The chassis is equipped with an air filter that is removable for cleaning and replacement.

4.1 Removing and Replacing the Air Filter

To ensure proper performance, the air filter of cPCIS-2501 should be cleaned or replaced as necessary.

Air Filter Removal and Replacement Procedure

1. Remove the screws attaching the air inlet grill on the underside of the chassis as shown below.

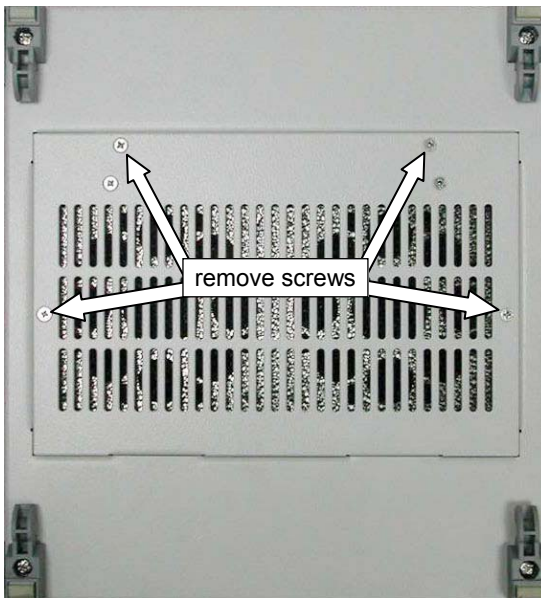

2. Lift the grill and attached fan module out of the chassis. Remove the remaining two screws attaching the fan module to the grill.

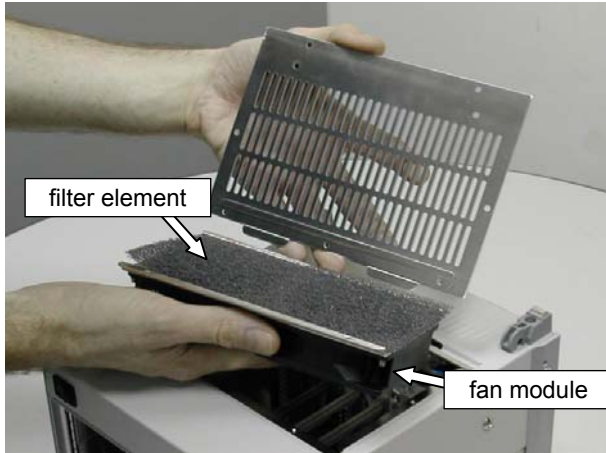

3. After cleaning or replacing the filter, place it back in position, secure the fan module to the inlet grill by replacing the two screws removed in Step 2, and re-install the grill into the chassis.

4.2 Fan Removal and Replacement

To remove the fan module from the chassis, follow the **Air Filter Removal and Replacement Procedure** above. Pull the fan power connectors out from behind the backplane as shown below. Disconnect the power cable, and replace with a functional fan module. Re-insert the connectors behind the backplane and replace the fan module/air inlet grill assembly.

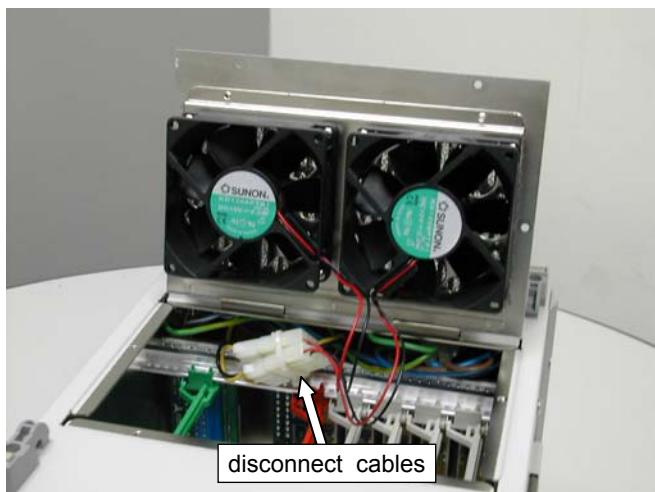

5 Power Supply Unit

The cPCIS-2501 is equipped with ADLINK's cPS-H325/AC CompactPCI power module.

5.1 CompactPCI: cPS-H325/AC

Features

- 250W 3U X 8HP Eurocard package
- Meets IEC1000-3-2 harmonic correction
- Internal OR-ing diodes for N+1 redundancy
- Hot-swappable
- Third-wire current sharing
- EMI meets EN 55022 / FCC CLASS A
- CE marking compliance
- Fully compliant with PICMG

Specifications

- Operating Temperature Range: 0 °C to 50 °C
- Storage Temperature: -40 to +85 °C
- Temperature Coefficient: Typ. $\pm 0.02\%$ / °C
- Cooling: >20 CFM moving air required to achieve full rated power
- Dimensions: Eurocard 3U X 8HP X 160mm CompactPCI format
- Efficiency: 78-79% typical
- Switching Frequency: 120K Hz
- Safety: IEC60950 Class I
- Circuit Topology: Forward circuit
- Transient Response: Peak transient less than 100mV and recovers within 2mS after 25% load-change

Input Characteristics

- Input Voltage: Typ. 90-264VAC
- Power Factor Correction: Meets Harmonic Correction IEC1000-3-2. Power Factor typ. 0.95-0.97
- Input Connector: Positronic 47-pin PCIH47M400A1
- Input Frequency: 47-63Hz
- Inrush Current: Less than 30A @ 230VAC
- Input Current: 2.8A @115VAC / 1.4A @230VAC
- Dielectric Withstand: Meets IEC950 regulation
- EMI: Meets EN55022 / FCC Class A
- Hold-up Time: 5mS after power fail signal
- Remote ON/OFF: Available at [INH#] & [EN#] pins
- Power Fail Signal: Available at [FAL#] pin
- Status LED: <Green> means valid input voltage; <Amber> means a critical fault.
- Thermal Protection (OTP): Installed NTC and thermostat for thermal sensor at [DEG#] pin
- Power OK: Installed at all outputs
- Leakage Current: Typ. 0.5mA

Output Characteristics

Output Voltage	Output Current (A)			
	MIN.	MAX.	TYP.	PEAK.
5V MAIN +VO1 @ ★ # ≡ ⊙	2.0	33.0	25.0	–
3.3V AUX. +VO2 ▲ @ ★ # ≡ ⊙	0	33	18	–
12V AUX. +VO3 ▲ ≡ # ⊙ ★ @	0	5.5	5.5	6
-12V AUX. –VO4 ● ⊙ ★ ■ =	0	1	0.5	1.5

Symbol: "★" OVP built-in; "@" Adjustable; "#" Remote sensing;
"≡" 3rd-wire Load Sharing; "=" Droop Current Sharing;
"⊙" Installed with Or-ing diode; "▲" Magnetic Amplifier;
"●" Installed with Post-regulator; "■" Common Choke.

Remarks: Peak load sustainable for less than 60sec. with duty cycle <10%.
Max. load is the continuous operating load of each rail. Max. load
of each rail cannot be drawn from all outputs at the same time.

- Over Load Protection: Fully protected against output overload or short circuit. Typical 120% max. load.
- Over Current Protection: Installed at each rail
- Output Wattage: Typ. 250W continuous.
- Output Connector: Positronic 47-pin PCIH47M400A1.
- Line Regulation: Typ. 0.1%.
- Load Regulation: Typ. $\pm 1-2\%$.
- Noise & Ripple: Typ. 1% peak to peak or 50mV, whichever is greater.
- OVP: Built-in at all outputs.
- Adjustability: Available at VO1, 2 & 3.
- Output Trim: Electrical trim available at VO1/VO2 [ADJ #].
- Remote Sensing: Available at VO1, VO2 & VO3.
- Hot-Swap: Available.
- N+1 Redundancy: Installed with internal OR-ing diodes at all outputs for N+1 redundancy operation.
- Current Sharing: Third-wire current sharing at VO1,2 &3.
- Power OK Signal: Available for all output.
- Over Current Protection: Installed at each rail.
- Overload Protection: Fully protected against output overload or short circuit. Typical 120% max. load.

Important Safety Instructions

Read and follow all instructions marked on the product and in the documentation before you operate your system. Retain all safety and operating instructions for future use.

- Please read these safety instructions carefully.
- Please keep this User's Manual for later reference.
- The equipment can be operated at an ambient temperature of 50°C.
- The equipment should be operated only from the type of power source indicated on the rating label. Make sure the voltage of the power source when connect the equipment to the power outlet.
- If your equipment has a voltage selector switch, make sure that the switch is in the proper position for your area. The voltage selector switch is set at the factory to the correct voltage.
- For pluggable equipment, that the socket-outlet shall be installed near the equipment and shall be easily accessible.
- Place the power cord such a way that people can not step on it. Do not place anything over the power cord.
- If the equipment is not use for long time, disconnect the equipment from mains to avoid being damaged by transient overvoltage.
- All cautions and warnings on the equipment should be noted.
- Please keep this equipment from humidity.
- Do not use this equipment near water or a heat source.
- Lay this equipment on a reliable surface when install. A drop or fall could cause injury.
- Never pour any liquid into opening; this could cause fire or electrical shock.
- Openings in the case are provided for ventilation. Do not block or cover these openings. Make sure you provide adequate space around the system for ventilation when you set up your work area. Never insert objects of any kind into the ventilation openings.
- To avoid electrical shock, always unplug all power cables and modem cables from the wall outlets before removing covers.

- Lithium Battery provided (real time clock battery)
“CAUTION – Risk of explosion if battery is replaced by an incorrect type. Dispose of used batteries according to the instructions”
- If one of the following situations arises, get the equipment checked by a service personnel:
 - A. The power cord or plug is damaged.
 - B. Liquid has penetrated into the equipment.
 - C. The equipment has been exposed to moisture.
 - D. The equipment has not work well or you can not get it work according to user’s manual.
 - E. The equipment has dropped and damaged.
 - F. If the equipment has obvious sign of breakage.

Warranty Policy

Thank you for choosing ADLINK. To understand your rights and enjoy all the after-sales services we offer, please read the following carefully.

1. Before using ADLINK's products please read the user manual and follow the instructions exactly. When sending in damaged products for repair, please attach an RMA application form which can be downloaded from: <http://rma.adlinktech.com/policy/>.
2. All ADLINK products come with a two-year guarantee
 - The warranty period starts from the product's shipment date from ADLINK's factory.
 - Peripherals and third-party products not manufactured by ADLINK will be covered by the original manufacturers' warranty.
 - For products containing storage devices (hard drives, flash cards, etc.), please back up your data before sending them for repair. ADLINK is not responsible for loss of data.
 - Please ensure the use of properly licensed software with our systems. ADLINK does not condone the use of pirated software and will not service systems using such software. ADLINK will not be held legally responsible for products shipped with unlicensed software installed by the user.
 - For general repairs, please do not include peripheral accessories. If peripherals need to be included, be certain to specify which items you sent on the RMA Request & Confirmation Form. ADLINK is not responsible for items not listed on the RMA Request & Confirmation Form.
3. Our repair service is not covered by ADLINK's two-year guarantee in the following situations:
 - Damage caused by not following instructions in the user's manual.
 - Damage caused by carelessness on the user's part during product transportation.
 - Damage caused by fire, earthquakes, floods, lightening, pollution, other acts of God, and/or incorrect usage of voltage transformers.
 - Damage caused by unsuitable storage environments (i.e. high temperatures, high humidity, or volatile chemicals).
 - Damage caused by leakage of battery fluid during or after change of batteries by customer/user.
 - Damage from improper repair by unauthorized technicians.
 - Products with altered and/or damaged serial numbers are not entitled to our service.
 - Other categories not protected under our warranty.
4. Customers are responsible for shipping costs to transport damaged products to our company or sales office.
5. To ensure the speed and quality of product repair, please download an RMA application form from our company website: <http://rma.adlinktech.com/policy/>. Damaged products with attached RMA forms receive priority.

If you have any further questions, please email our FAE staff: service@adlinktech.com.