

**NAT-PM-AC600
NAT-PM-AC600D
NAT-PM-AC1000
MTCA Power Module
Technical Reference Manual V1.3**

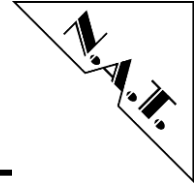

The NAT-PM-AC600 has been designed by:

**N.A.T. GmbH
Konrad-Zuse-Platz 9
53227 Bonn-Oberkassel**

**Phone: +49 / 228 / 96 58 64 0
Fax: +49 / 228 / 96 58 64 10**

Internet: <http://www.nateurope.com>

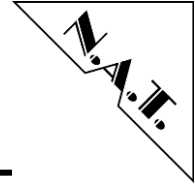

Disclaimer

The following documentation, compiled by N.A.T. GmbH (henceforth called N.A.T.), represents the current status of the product's development. The documentation is updated on a regular basis. Any changes which might ensue, including those necessitated by updated specifications, are considered in the latest version of this documentation. N.A.T. is under no obligation to notify any person, organization, or institution of such changes or to make these changes public in any other way.

We must caution you, that this publication could include technical inaccuracies or typographical errors.

N.A.T. offers no warranty, either expressed or implied, for the contents of this documentation or for the product described therein, including but not limited to the warranties of merchantability or the fitness of the product for any specific purpose.

In no event will N.A.T. be liable for any loss of data or for errors in data utilization or processing resulting from the use of this product or the documentation. In particular, N.A.T. will not be responsible for any direct or indirect damages (including lost profits, lost savings, delays or interruptions in the flow of business activities, including but not limited to, special, incidental, consequential, or other similar damages) arising out of the use of or inability to use this product or the associated documentation, even if N.A.T. or any authorized N.A.T. representative has been advised of the possibility of such damages.

The use of registered names, trademarks, etc. in this publication does not imply, even in the absence of a specific statement, that such names are exempt from the relevant protective laws and regulations (patent laws, trade mark laws, etc.) and therefore free for general use. In no case does N.A.T. guarantee that the information given in this documentation is free of such third-party rights.

Neither this documentation nor any part thereof may be copied, translated, or reduced to any electronic medium or machine form without the prior written consent from N.A.T. GmbH.

This product (and the associated documentation) is governed by the N.A.T. General Conditions and Terms of Delivery and Payment.

Note:

The release of the Hardware Manual is related to a certain HW board revision given in the document title. For HW revisions earlier than the one given in the document title please contact N.A.T. for the corresponding older Hardware Manual release.

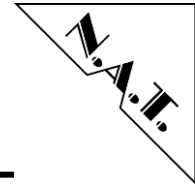
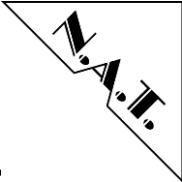

Table of Contents

TABLE OF CONTENTS	4
LIST OF TABLES	5
LIST OF FIGURES	5
CONVENTIONS	6
1 INTRODUCTION	7
2 OVERVIEW	8
2.1 MAJOR FEATURES	8
2.2 BLOCK DIAGRAM	8
3 BOARD FEATURES	9
3.1 EMMC	9
3.2 REDUNDANCY AND LOAD SHARING	9
3.3 LED INDICATORS	9
3.4 APPLICATIONS	9
3.5 SENSORS	10
4 TECHNICAL DATA	11
5 HARDWARE	12
5.1 FRONT PANEL AND LEDs	12
5.2 CONNECTORS	13
5.2.1 P1: Backplane Power Connector	13
5.2.2 SW1: Hot Swap Switch	13
6 OPERATION	14
6.1 INSERTION / POWER UP	14
6.2 POWER DOWN / EXTRACTION	14
6.3 CHANNEL CURRENT LIMIT	14
6.4 FIRMWARE UPDATE	14
6.5 POWER CYCLE	15
6.6 AIRFLOW REQUIREMENTS	15
7 BOARD SPECIFICATION	16
8 STATEMENT ON ENVIRONMENTAL PROTECTION	17
8.1.1 Compliance to RoHS Directive	17
8.1.2 Compliance to WEEE Directive	17
8.1.3 Compliance to CE Directive	18
8.1.4 Product Safety	18
8.1.5 Compliance to REACH	18
9 KNOWN BUGS / RESTRICTIONS	19
APPENDIX A: REFERENCE DOCUMENTATION	20
APPENDIX B: DOCUMENT'S HISTORY	21



List of Tables

Table 1: List of used abbreviations 6
Table 2: Sensor Overview.....10
Table 3: P1: Power Connector Part A – High Power Pins13
Table 4: P1: Power Connector Part B – Control Signal and Management Power13
Table 5: NAT-PM-AC600/600D/1000 Specification16

List of Figures

Figure 1: NAT-PM-AC600 7
Figure 2: NAT-PM-AC600 – Block Diagram..... 8
Figure 3: NAT-PM-AC600 – Front Panel View.....12

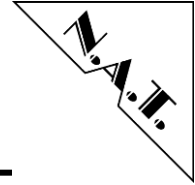

Conventions

If not otherwise specified, addresses and memory maps are written in hexadecimal notation, identified by 0x.

The following table gives a list of the abbreviations used in this document.

Table 1: List of used abbreviations

Abbreviation	Description
AC	Alternating Current
AMC	Advanced Mezzanine Card
CPU	Central Processing Unit
CU	Cooling Unit
EMI	Electromagnetic Interference
EMMC	Enhanced MMC
HPM	Hardware Platform Management
IPMB	Intelligent Platform Management Bus
IPMI	Intelligent Platform Management Interface
LED	Light Emitting Diode
μTCA/MTCA	Micro Telecommunications Computing Architecture
MCH	μTCA/MTCA Carrier Hub
MMC	Module Management Controller
PFC	Power Factor Correction
PM	Power Module
SMP	Shared Management Power

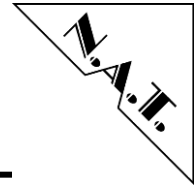

1 Introduction

The **NAT-PM-AC600/600D/1000** is a family of high density, high-efficiency power modules (PM) for MicroTCA applications. Supplying 600W (AC600/600D) or 1000W (AC1000) payload power makes it the market's most efficient PM to run today's complex communication systems that use latest processor generations with large memory capacity and an increased number of Advanced Mezzanine Cards (AMC). Its design provides state of the art power conversion technology with peak conversion efficiency of 90%.

The **NAT-PM-AC600/600D/1000** is ideally suited to run latest high availability MicroTCA systems with fast CPUs and large memory arrays where power feeding is crucial and therefore requiring high-performance electrical power modules. It provides payload and management power for up to 12 Advanced Mezzanine Cards, 2 Cooling Units and 2 MicroTCA carrier Hub (MCH) modules.

All AC power modules offer power conversion from universal line input (85V-265VAC) and sources up to 16 independent 12V channels for payload power and 3.3V for management power. It supplies backup power for other power modules (Shared Management Power, SMP) within the system. It is available as single-width (AC600) and double width (AC600D/AC1000), full-size module.

The following figure shows a photo of the **NAT-PM-AC600**.

Figure 1: NAT-PM-AC600



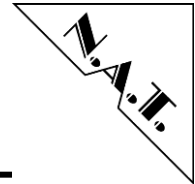

2 Overview

2.1 Major Features

- EMI Filtering providing EN55022 Class A and B compliance
- inrush control
- Power factor correction circuitry (PFC)
- holdup circuit
- high-efficiency power conversion
- load indicator
- power management for 16 power channels
- backup power for other PM (SMP)
- support for N+1, 2+2 redundancy and load sharing
- HPM firmware upgrade support

2.2 Block Diagram

The following figure shows a block diagram of the **NAT-PM-AC600**.

Figure 2: NAT-PM-AC600 – Block Diagram

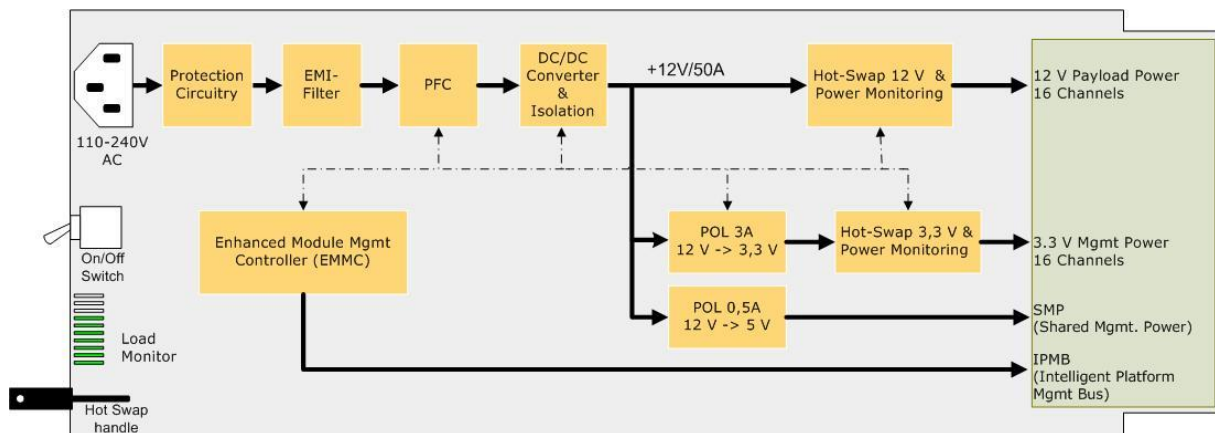

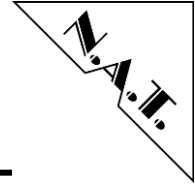

3 Board Features

3.1 EMMC

The **NAT-PM-AC600/600D/1000** includes a robust Enhanced Module Management Controller (EMMC) that interfaces the power control functionality via an Intelligent Platform Management Bus (IPMB) to the MicroTCA Carrier Hub (MCH).

3.2 Redundancy and Load Sharing

The **NAT-PM-AC600/600D/1000** supports redundancy as well as load sharing modes in accordance with the MicroTCA specifications. In case of an input power supply failure the on-board EMMC can be supplied with SMP power by other power modules, so that the System/Carrier Manager is able to analyze the root cause failure.

3.3 LED Indicators

Besides the standard indicator LEDs for hot-swap, failure and heartbeat the **NAT-PM-AC600/600D/1000** has a unique light bar indicator, showing the total power load of the module on a scale from 0 to 100% in real time.

3.4 Applications

All N.A.T. power modules are hot swappable, fully redundant power module. The module's single-width design offers perfect thermal performance and is therefore ideally suited for all air cooled MicroTCA solutions. It supports all redundancy schemes as well as load sharing applications. The power module's software has been developed and debugged using the **NAT-MCH** as a reference tool. It is fully compatible with any cards or modules inserted into a MicroTCA chassis.

Application areas are

- commercial-, military-, and telecommunication applications
- automation test equipment
- medical or security tasks
- video demand services
- industrial machine control and other clustered computing applications

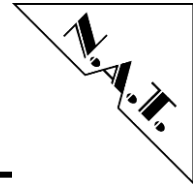

3.5 Sensors

The **NAT-PM-AC600/600D/1000** features several sensors to capture and monitor the temperature-, voltage-, and current-conditions of the module. Details are shown in the following table.

Table 2: Sensor Overview

Sensor #	Sensor Type	Name	Description
1	Temp	T_CPU	Temperature of CPU
2	Temp	T_XFRM	Temperature of Transformer
3	Temp	T-PSB	Temperature of Bridge Transistors
4	Temp	T-PFC	Temperature of PFC-Unit
5	Temp	T-REC	Temperature of Rectifier
6	Voltage	VINAC	Input Voltage AC
7	Voltage	VINDC	Input Voltage DC
8	Voltage	12V	12V Monitoring
9	Voltage	3.3V	3.3V Monitoring
10	Current	I_Sum	Sum of all Power Channels
11	Current	I_CH01	Power Channel 1 – MCH1
12	Current	I_CH02	Power Channel 2 – MCH2
13	Current	I_CH03	Power Channel 3 – CU1
14	Current	I_CH04	Power Channel 4 – CU2
15	Current	I_CH05	Power Channel 5 – AMC1
16	Current	I_CH06	Power Channel 6 – AMC2
17	Current	I_CH07	Power Channel 7 – AMC3
18	Current	I_CH08	Power Channel 8 – AMC4
19	Current	I_CH09	Power Channel 9 – AMC5
20	Current	I_CH10	Power Channel 10 – AMC6
21	Current	I_CH11	Power Channel 11 – AMC7
22	Current	I_CH12	Power Channel 12 – AMC8
23	Current	I_CH13	Power Channel 13 – AMC9
24	Current	I_CH14	Power Channel 14 – AMC10
25	Current	I_CH15	Power Channel 15 – AMC11
26	Current	I_CH16	Power Channel 16 – AMC12

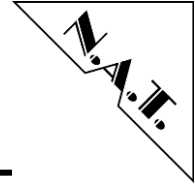

4 Technical Data

- 85VAC-265VAC universal line input
- 600W/1000W output power (*)
- support of N+1 and 2+2 redundancy
- 16 power channels of
 - 12V
 - 3.3V
- support of
 - 12 AMCs, 2 CUs, 2 MCHs
 - with individual control of management and payload power
- 90% peak conversion efficiency
- HPM firmware upgrade support
- single-width, full-size (AC600)
- double-width, full-size (AC600D)
- Intelligent Security System
 - output over-voltage and over-temperature-protection
 - input under-voltage-shutdown
 - output short-circuit-protection
 - programmable current limiting threshold per output channel
- Front Panel
 - power input plug
 - On/Off Switch
 - optical load indicator
 - hot swap handle and blue LED
 - health indicator LED
 - heartbeat indicator LED
- Standard Compliance
 - PICMG MicroTCA.0 R1.0
 - PICMG AMC.0 R2.0
 - IPMI v1.5 and v2.0
 - Safety and EMI standard compliance
 - RoHS compliant

(*) guaranteed for AC line input 115VAC-265VAC and sufficient cooling

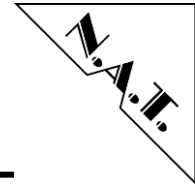

5 Hardware

5.1 Front Panel and LEDs

Figure 3: NAT-PM-AC600 – Front Panel View

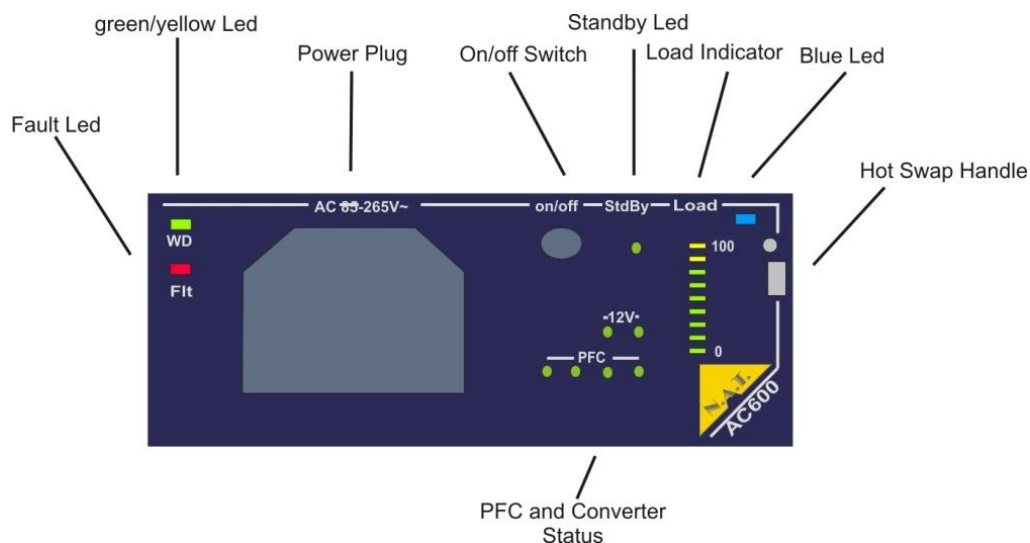

Elements of the front panel:

- AC Power Plug
- Hot Swap Handle: AMC.0 conformant hot swap and extraction handle
- On/Off Switch: "On" position is left
- Load Indicator Bar: indicates the overall load of the module in 10% steps
- LEDs:
 - LED HS: MTCA.0 Blue LED
 - LED FTL: red LED indicating the power module is not healthy and thus not able to provide power to the system
 - LED WD:
 - solid green: PM is the startup PM and runs in autonomous mode
 - green blinking: PM is primary and shows the heartbeat from the MCH (managed mode)
 - solid yellow: PM has come up as secondary PM and is not managed
 - yellow blinking. PM is secondary and shows the heartbeat of the MCH (managed mode)
 - LED PFC:
 - Green: PFC stage active
 - red: PFC Stage overheat
 - LED 12V:
 - green: power converter stage active
 - Red: power converter stage overheat
 - LED StdBy:
 - Green: power module switched on
 - Yellow: power module switched off, standby

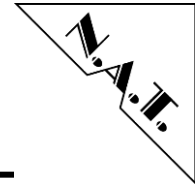

5.2 Connectors

5.2.1 P1: Backplane Power Connector

Table 3: P1: Power Connector Part A – High Power Pins

Pin #	Signal	Signal	Pin #
P1	PP_M1	PP_AMC1	P13
P2	PP_CU1	PP_AMC2	P14
P3	PP_CU2	PP_AMC3	P15
P4	GND	PP_AMC4	P16
P5	GND	PP_AMC5	P17
P5	GND	PP_AMC6	P18
P7	GND	PP_AMC7	P19
P8	GND	PP_AMC8	P20
P9	GND	PP_AMC9	P21
P10	GND	PP_AMC10	P22
P11	GND	PP_AMC11	P23
P12	PP_M2	PP_AMC12	P24

Table 4: P1: Power Connector Part B – Control Signal and Management Power

Pin	A	B	C	D	E	F	G	H
1	PS_PM#	PM_OK#	PS1_M1 #	PS1_CU 1#	EN_M1#	EN_CU1 #	MP_M1	MP_CU1
2	TCK	PMP_A#	PS1_2#	PS1_1#	EN_2#	EN_1#	MP_2	MP_1
3	TMS	PMP_B#	PS1_4#	PS1_3#	EN_4#	EN_3#	MP_4	MP_3
4	TRST#	PMP_C#	PS1_6#	PS1_5#	EN_6#	EN_5#	MP_6	MP_5
5	TDO	RST_PM _IN#	PS1_8#	PS1_7#	EN_8#	EN_7#	MP_8	MP_7
6	TDI	RST_PM _A#	PS1_10 #	PS1_9#	EN_10#	EN_9#	MP_10	MP_9
7	GA0	RST_PM _B#	PS1_12 #	PS1_11 #	EN_12#	EN_11#	MP_12	MP_11
8	GA1	RST_PM _C#	PS1_M2 #	PS1_CU 2#	EN_M2#	EN_CU2 #	MP_M2	MP_CU2
9	GA2	SMP	SCL_B	SDA_B	SCL_A	SDA_A	PWR_ON _M2	PWR_ON _M1

5.2.2 SW1: Hot Swap Switch

Switch SW1 is used to support hot swapping of the module. It conforms to PICMG AMC.0.

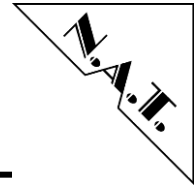

6 Operation

6.1 Insertion / Power up

After placing the **NAT-PM-AC600** in a MTCA Rack the system is powered up as soon as the line power is available and the On/Off switch is placed in the "On" position. The cooling units and MCHs are powered up in autonomous mode. As soon as the MCH has taken control over the system, the green WD LED starts to blink. From this time on the power module is under control of the MCH. The MCH is responsible for directing the power module to power up further AMCs in the system.

6.2 Power down / Extraction

The power down / hot swap process is started by pulling the module's hot swap handle. In a non-redundant system the MCH will switch off payload and management power channels for the AMCs, cooling units and the MCH itself. In a redundant system finally the system remains powered by the second power module.

As soon as the power module's blue LED of is solid on the module is ready for extraction. If the On/Off switch is placed in the "Off" position, system power is cut right away. In redundant systems the system stays active if powered by the second power module.

6.3 Channel Current Limit

According to the AMC.0 and MTCA.0 specification each payload module in a μ TCA system has to provide a power budget to the MCH. The MCH communicates this power budget to the power modules.

The **NAT-PM-AC600/600D/1000** supervises the current for each of the payload channels and turns a power channel off if the measured current exceeds the requested power budget for the respective module. The power module can provide a maximum current of 9.2A per channel (= 106W at 11.6V). The current limit can be adjusted in 5% steps down to 2.3A minimum current limit. An additional margin of 5% is added to the requested power budget to compensate for component tolerances and parasitic effects.

6.4 Firmware Update

The **NAT-PM-AC600/600D/1000** supports firmware updates by the HPM (Hardware Platform Management) upgrade mechanism.

Update files usually are provided in compressed format (.zip) and need to be un-compressed before the update can be executed.

The update can be executed by "NATView" or any other IPMI /RMCP front end tool.

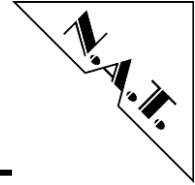

6.5 Power Cycle

If a power cycle is done by disconnecting the power module from mains, it is recommended to wait until the module has discharged completely (all Leds off) before re-applying power again. This ensures that the power module executes a clean cold start.

6.6 Airflow Requirements

The peak conversion efficiency of the **NAT-PM-AC600/600D/1000** is 90% or better. When operating under full load this means that still 60W (100W for the AC1000) of heat dissipation must be disposed by the airflow. Insufficient airflow degrades the maximum available output power.

WARNING

Operating the **NAT-PM-AC600/600D/1000** under full load requires a minimum air flow of

5m/sec \approx 75m³/h \approx 50 CFM

The maximum ambient temperature at the power module shall not exceed 50°C. For best performance and to prevent excessive stress on the power module it is recommended to keep the environmental conditions below 30°C.

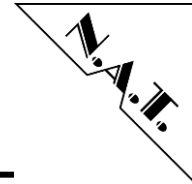

7 Board Specification

Table 5: NAT-PM-AC600/600D/1000 Specification

Processor	Atmel xMega		
FPGA	Lattice MACHXO2		
Form Factor	single width, full size		
Front-I/O	AC universal line input plug		
Power consumption	1W standby		
Input Voltage	85VAC-265VC		
AC Line Fuse	8A		
Isolation	3KV		
Input/Output			
12V power sub system	Output Voltage	12.4V primary mode 11.6V secondary mode	
	Max. Output Power 12V	AC600/AC600D	50A
		AC1000	80A
	Max. Ripple	AC600	20mV
		AC600D	10mV
		AC1000	10mV
Accuracy	+-50mV		
3.3V sub system	Output Voltage	3.4V	
	Max. Output Power 3.3V	3A	
	Max. Ripple	20mV	
	Accuracy	+-20mV	
Airflow Requirements	3m/sec ≈ 50CFM at full load		
Environmental conditions	Temperature (operating):	-5°C to +50°C with forced air cooling	
	Temperature (storage):	-40°C to +85°C	
	Humidity:	10 % to 90 % rh non-condensing	
MTBF	4.835270FIT / 204814 hours	MIL217	
Standards compliance	AMC and μTCA	PICMG AMC.0 Rev. 2.0 IPMI Specification v2.0 Rev. 1.0 PICMG μTCA.0 Rev. 1.0 IEC/EN/UL60950-1 safety	
	Safety	IEC/EN/UL60950-1 safety (**)	
	EMI	EN55022 Class A/B (**)	

(*) guaranteed for 115VAC-265VAC, below 115VAC input output power is degraded by 2%/Volt

(**) for details please refer to the **NAT-PM-AC600/600D/1000** CE-Report

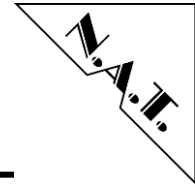

8 Statement on Environmental Protection

8.1.1 Compliance to RoHS Directive

Directive 2011/65/EU of the European Parliament and of the Council of 8 June 2011 on the "Restriction of the use of certain Hazardous Substances in Electrical and Electronic Equipment" (RoHS) predicts that all electrical and electronic equipment being put on the European market after June 30th, 2006 must contain lead, mercury, hexavalent chromium, polybrominated biphenyls (PBB) and polybrominated diphenyl ethers (PBDE) and cadmium in maximum concentration values of 0.1% respective 0.01% by weight in homogenous materials only.

As these hazardous substances are currently used with semiconductors, plastics (i.e. semiconductor packages, connectors) and soldering tin any hardware product is affected by the RoHS directive if it does not belong to one of the groups of products exempted from the RoHS directive.

Although many of hardware products of N.A.T. are exempted from the RoHS directive it is a declared policy of N.A.T. to provide all products fully compliant to the RoHS directive as soon as possible. For this purpose since January 31st, 2005 N.A.T. is requesting RoHS compliant deliveries from its suppliers. Special attention and care has been paid to the production cycle, so that wherever and whenever possible RoHS components are used with N.A.T. hardware products already.

8.1.2 Compliance to WEEE Directive

Directive 2002/95/EC of the European Commission on "Waste Electrical and Electronic Equipment" (WEEE) predicts that every manufacturer of electrical and electronic equipment which is put on the European market has to contribute to the reuse, recycling and other forms of recovery of such waste so as to reduce disposal. Moreover this directive refers to the Directive 2002/95/EC of the European Commission on the "Restriction of the use of certain Hazardous Substances in Electrical and Electronic Equipment" (RoHS).

Having its main focus on private persons and households using such electrical and electronic equipment the directive also affects business-to-business relationships. The directive is quite restrictive on how such waste of private persons and households has to be handled by the supplier/manufacturer; however, it allows a greater flexibility in business-to-business relationships. This pays tribute to the fact with industrial use electrical and electronic products are commonly integrated into larger and more complex environments or systems that cannot easily be split up again when it comes to their disposal at the end of their life cycles.

As N.A.T. products are solely sold to industrial customers, by special arrangement at time of purchase the customer agreed to take the responsibility for a WEEE compliant disposal of the used N.A.T. product. Moreover, all N.A.T. products are marked according to the directive with a crossed out bin to indicate that these products within the European Community must not be disposed with regular waste.

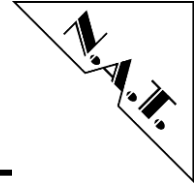

If you have any questions on the policy of N.A.T. regarding the Directive 2011/65/EU of the European Parliament and of the Council of 8 June 2011 on the "Restriction of the use of certain Hazardous Substances in Electrical and Electronic Equipment" (RoHS) or the Directive 2002/95/EC of the European Commission on "Waste Electrical and Electronic Equipment" (WEEE) please contact N.A.T. by phone or e-mail.

8.1.3 Compliance to CE Directive

Compliance to the CE directive is declared. A 'CE' sign can be found on the PCB.

8.1.4 Product Safety

The board complies with EN60950 and UL1950.

8.1.5 Compliance to REACH

The REACH EU regulation (Regulation (EC) No 1907/2006) is known to N.A.T. GmbH. N.A.T. did not receive information from their European suppliers of substances of very high concern of the ECHA candidate list. Article 7(2) of REACH is notable as no substances are intentionally being released by NAT products and as no hazardous substances are contained. Information remains in effect or will be otherwise stated immediately to our customers.

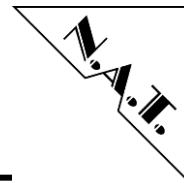

9 Known Bugs / Restrictions

none

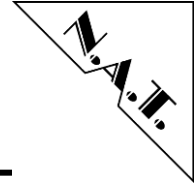

Appendix A: Reference Documentation

- [1] Lattice MACHXO2, DS1035 Version 02.4, February 2014
- [2] Atmel ATxmega128, Data Sheet 8385G-AVR-11/2013

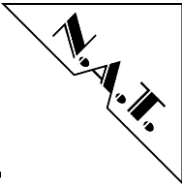

Appendix B: Document’s History

Revision	Date	Description	Author
1.0	05.04.2014	Initial Release	hl
1.1	06.05.2014	Added MTBF value, added Chapt. 6.3	hl
	14.10.2014	Updated Table 1 “Abbreviation List” Added Figure 1 (photo of the module) Added chapter 3.5: “Sensors” Updated Chapter 7 RoHS/REACH New arrangement of single chapters/paragraphs Minor changes, such as typo correction	se
	23.1.2014	Added reference to NAT-PM-AC600D	HI
1.2	29.4.2015	Added chapter Firmware Update and Power Cycle	hl
1.3	14.7.2016	Added reference to NAT-PM-AC1000	hl